

Thyristor Module

K03TA100P080AAA

特徴

Feature

- ・ RoHS 指令準拠
RoHS Compliant

用途

Application

- ・ 一般整流用
For General Use



外形図

Outline Drawing

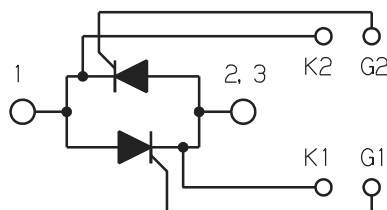
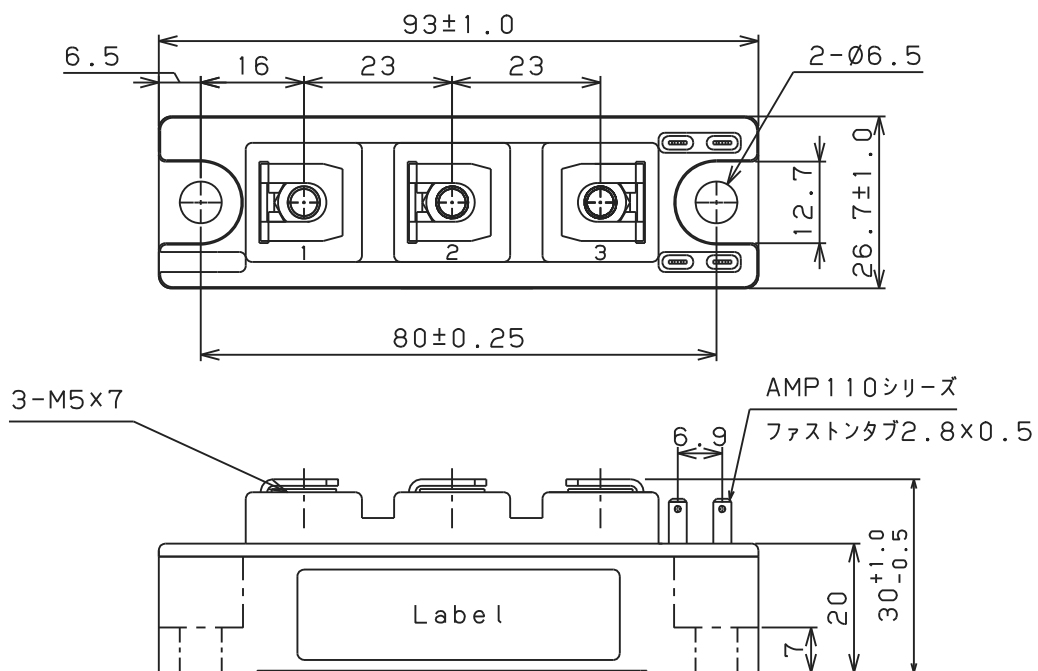

回路構成 Circuit Schema

【単位：mm】

最大定格 Maximum Ratings

項目 Parameter	記号 Symbol	耐圧クラス Grade		単位 Unit
		K03TA100P080AAA		
くり返しピークオフ電圧 Repetitive Peak Off-State Voltage	V _{DRM}	800		V
非くり返しピークオフ電圧 Non Repetitive Peak Off-State Voltage	V _{DSM}	900		V
くり返しピーク逆電圧 Repetitive Peak Reverse Voltage	V _{RRM}	800		V
非くり返しピーク逆電圧 Non Repetitive Peak Reverse Voltage	V _{RSM}	900		V

項目 Parameter	記号 Symbol	条件 Conditions	定格値 Max. Rated Value	単位 Unit		
平均整流電流 Average Rectified Output Current	I _{T(AV)}	商用周波数 180° 通電 Tc=82°C Half Sine Wave	100	A		
実効オン電流 RMS On-State Current	I _T (RMS)		156	A		
サージオン電流 Surge On-State Current	I _{TSM}	50Hz 正弦半波, 1 サイクル, 非くり返し Half Sine Wave, 1Pulse, Non-Repetitive	2000	A		
電流二乗時間積 I Squared t	I ² t	2~10ms	20000	A ² s		
臨界オン電流上昇率 Critical Rate of Rise of Turned-On Current	di/dt	V _D = 2/3V _{DRM} I _{TM} = 2I _T , T _j = 125°C I _G = 200mA, di _G /dt= 0.2A/μs	100	A/μs		
ピークゲート電力損失 Peak Gate Power	P _{GM}		5	W		
平均ゲート電力損失 Average Gate Power	P _{G(AV)}		1	W		
ピークゲート電流 Peak Gate Current	I _{GM}		2	A		
ピークゲート電圧 Peak Gate Voltage	V _{GM}		10	V		
ピークゲート逆電圧 Peak Gate Reverse Voltage	V _{RGM}		5	V		
動作接合温度範囲 Operating Junction Temperature Range	T _{jw}		-40 ~ +125	°C		
保存温度範囲 Storage Temperature Range	T _{stg}		-40 ~ +125	°C		
絶縁耐圧 Isolation Voltage	V _{iso}	端子-ベース間, AC 1 分間 Terminal to Base, AC 1min.	2500	V		
締付トルク Mounting Torque	ベース部 Base	F	サーマルコンパウンド塗布 Greased	M6	2.5 ~ 3.5	N・m
	主端子部 Terminal			M5	2.4 ~ 2.8	N・m

1 アーム当りの値 Value Per 1 Arm.

電氣的特性 Electrical Characteristics

項目 Parameter	記号 Symbol	条件 Conditions		特性値 Values			単位 Unit
				最小 Min.	標準 Typ.	最大 Max.	
ピークオフ電流 Peak Off-State Current	I_{DM}	$T_j = 125^\circ\text{C}$, $V_{DM} = V_{DRM}$				20	mA
ピーク逆電流 Peak Reverse Current	I_{RM}	$T_j = 125^\circ\text{C}$, $V_{RM} = V_{RRM}$				20	mA
ピークオン電圧 Peak On-State Voltage	V_{TM}	$T_j = 25^\circ\text{C}$ $I_{TM} = 300\text{A}$	Terminal			1.45	V
			Chip			1.26	
	$V_{(TO)}^{*1}$	$T_j = 125^\circ\text{C}$				0.82	V
	r_t^{*1}	$T_j = 125^\circ\text{C}$				1.34	m Ω
トリガゲート電流 Gate Current to Trigger	I_{GT}	$V_D = 6\text{V}$, $I_T = 1\text{A}$	$T_j = -40^\circ\text{C}$			200	mA
			$T_j = 25^\circ\text{C}$			100	mA
			$T_j = 125^\circ\text{C}$			50	mA
トリガゲート電圧 Gate Voltage to Trigger	V_{GT}	$V_D = 6\text{V}$, $I_T = 1\text{A}$	$T_j = -40^\circ\text{C}$			4	V
			$T_j = 25^\circ\text{C}$			2.5	V
			$T_j = 125^\circ\text{C}$			2	V
非トリガゲート電圧 Gate Non-Trigger Voltage	V_{GD}	$T_j = 125^\circ\text{C}$, $V_D = 2/3V_{DRM}$		0.25			V
臨界オフ電圧上昇率 Critical Rate of Rise of Off-State Voltage	dv/dt	$T_j = 125^\circ\text{C}$, $V_D = 2/3V_{DRM}$, $R_{GK} = 33\Omega$		500			V/ μs
ターンオフ時間 Turn-Off Time	t_q	$T_j = 125^\circ\text{C}$, $I_{TM} = I_T$, $V_D = 2/3V_{DRM}$ $dv/dt = 20\text{V}/\mu\text{s}$, $V_R = 100\text{V}$, $-di/dt = 20\text{A}/\mu\text{s}$			100		μs
ターンオン時間 Turn-On Time	t_{gt}				6		μs
遅れ時間 Delay Time	t_d	$T_j = 25^\circ\text{C}$, $V_D = 2/3V_{DRM}$ $I_G = 200\text{mA}$, $di_G/dt = 0.2\text{A}/\mu\text{s}$			2		μs
立上がり時間 Rise Time	t_r				4		μs
ラッチング電流 Latching Current	I_L	$T_j = 25^\circ\text{C}$			100		mA
保持電流 Holding Current	I_H	$T_j = 25^\circ\text{C}$			50		mA
熱抵抗 Thermal Resistance	$R_{th(j-c)}$	接合部-ケース間(T_c 測定点:チップ直下) Junction to Case				0.3	$^\circ\text{C}/\text{W}$
接触熱抵抗 Thermal Resistance	$R_{th(c-f)}$	ケース-フィン間, サーマルコンパウンド塗布 Case to Fin, Greased				0.2	$^\circ\text{C}/\text{W}$

質量 --- 約 120g Approximate Weight

1 アーム当りの値 Value Per 1 Arm.

*1 : $V_T \cong V_{(TO)} + I_T \times r_t$ For power-loss calculation only

オン電圧特性
ON-STATE CURRENT VS. VOLTAGE

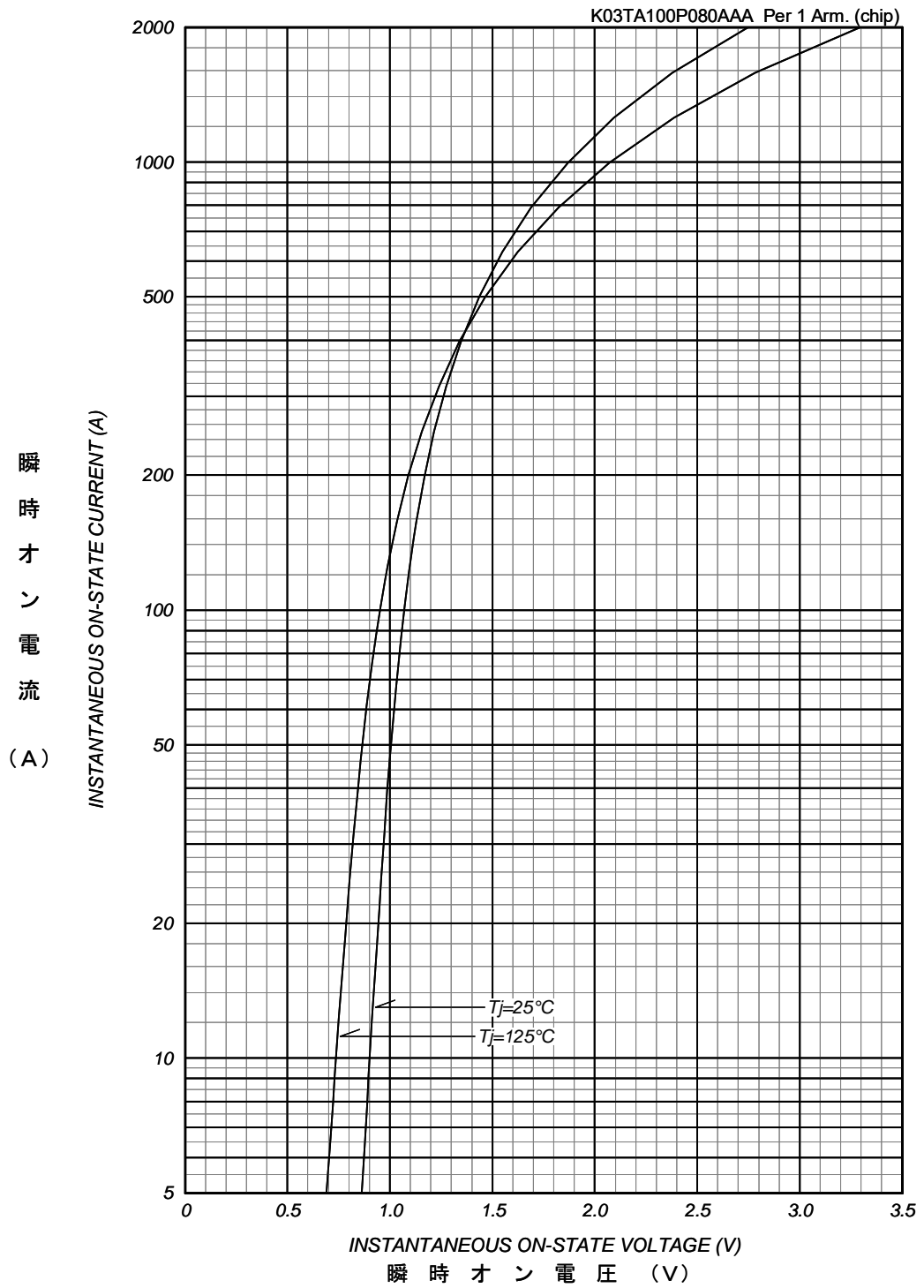

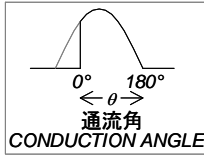

平均オン電力損失特性
 AVERAGE ON-STATE POWER DISSIPATION

for SINUSOIDAL CURRENT WAVEFORM

K03TA100P080AAA Per 1 Arm. (chip)

平均オン電力損失 (W)

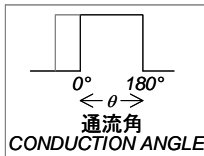
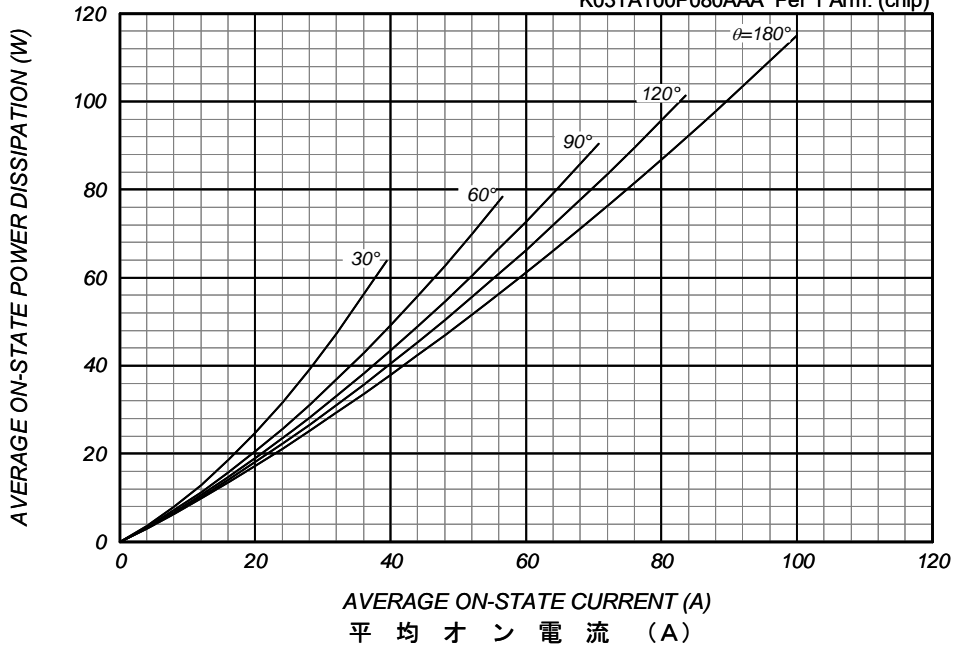

平均オン電力損失特性
 AVERAGE ON-STATE POWER DISSIPATION

for RECTANGULAR CURRENT WAVEFORM

K03TA100P080AAA Per 1 Arm. (chip)

平均オン電力損失 (W)

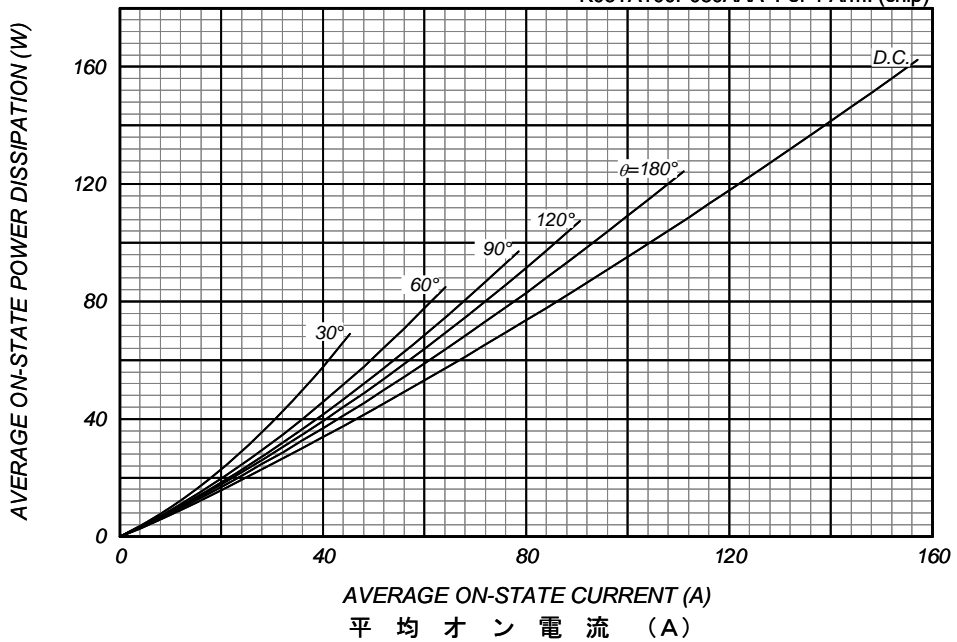

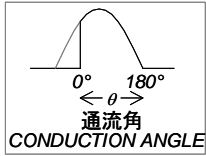

平均オン電流 - ケース温度定格
 AVERAGE ON-STATE CURRENT VS. CASE TEMPERATURE

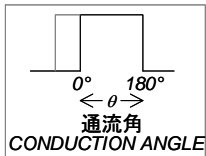
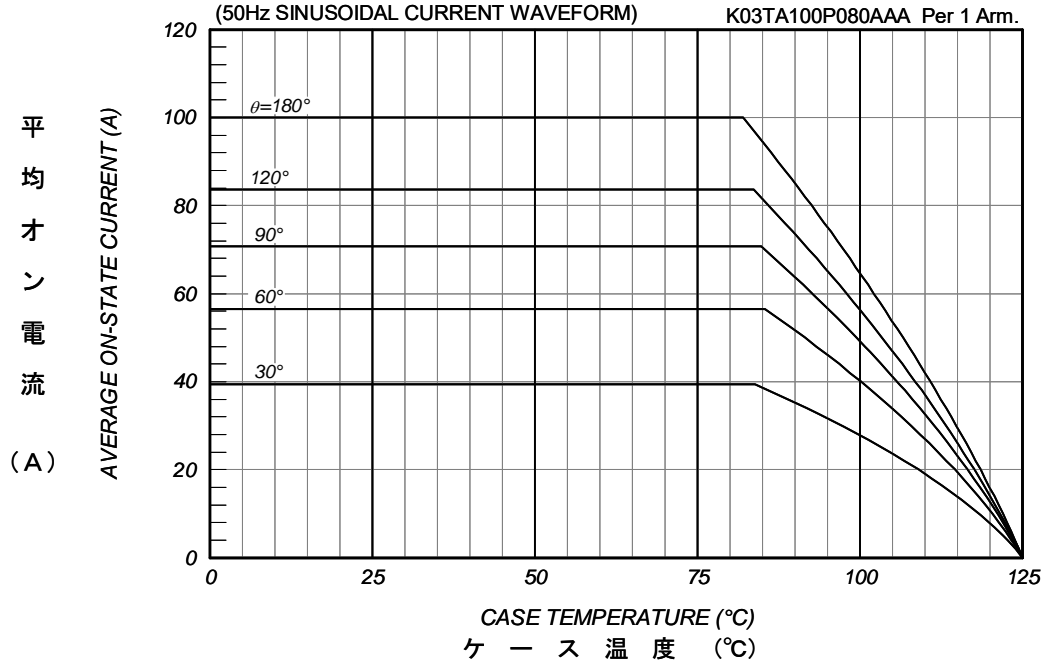

平均オン電流 - ケース温度定格
 AVERAGE ON-STATE CURRENT VS. CASE TEMPERATURE

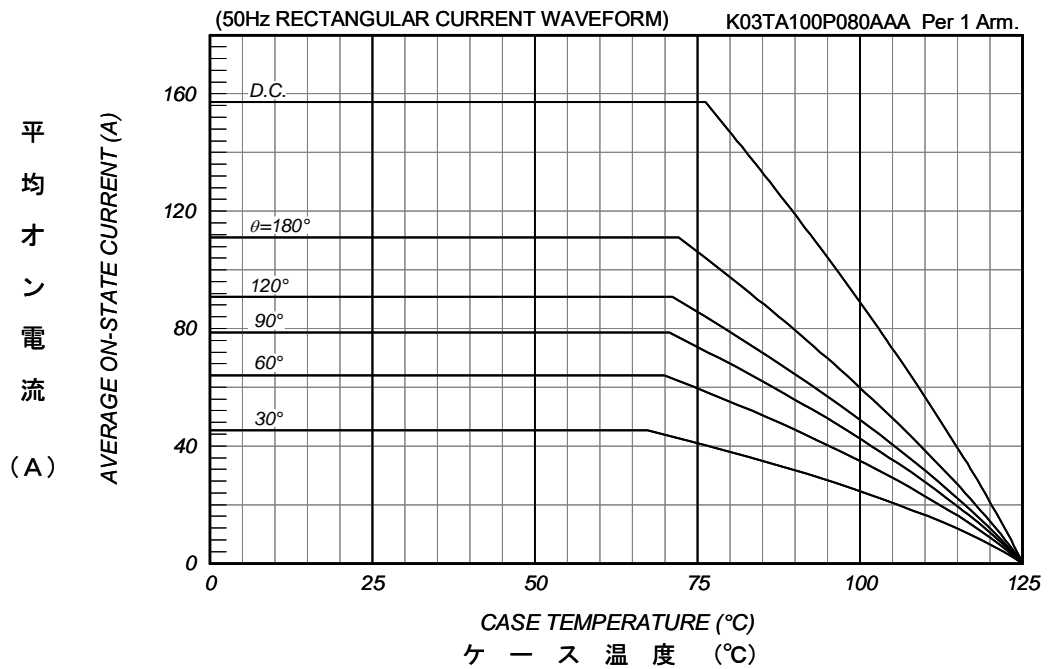

ゲート特性
GATE CHARACTERISTICS

K03TA100P080AAA

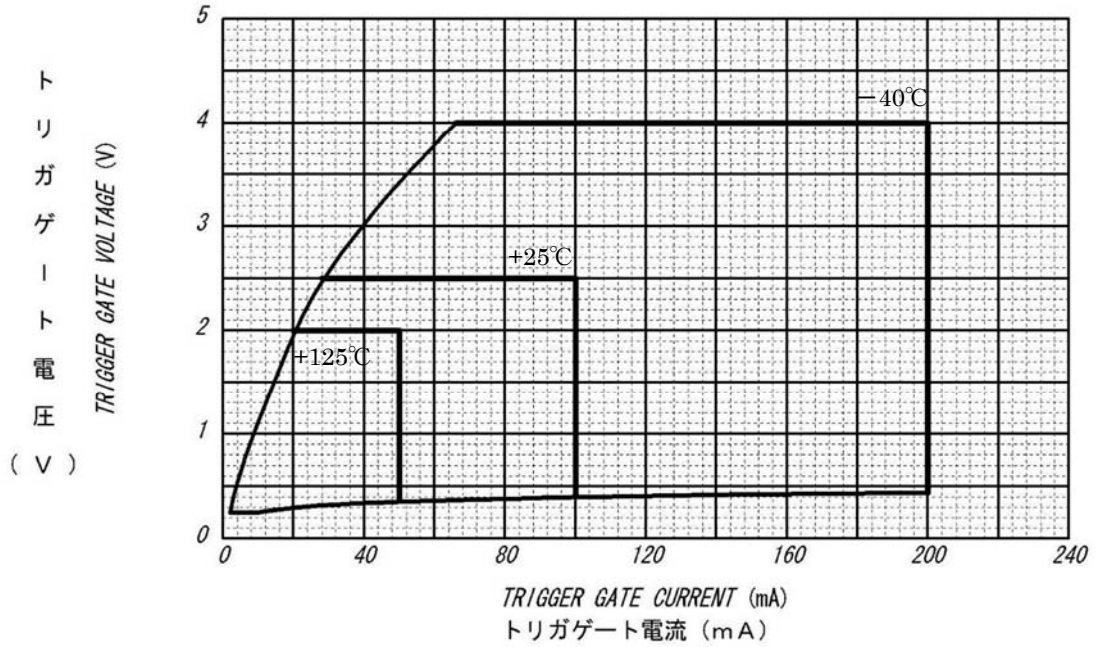

ゲート定格
GATE RATINGS

K03TA100P080AAA

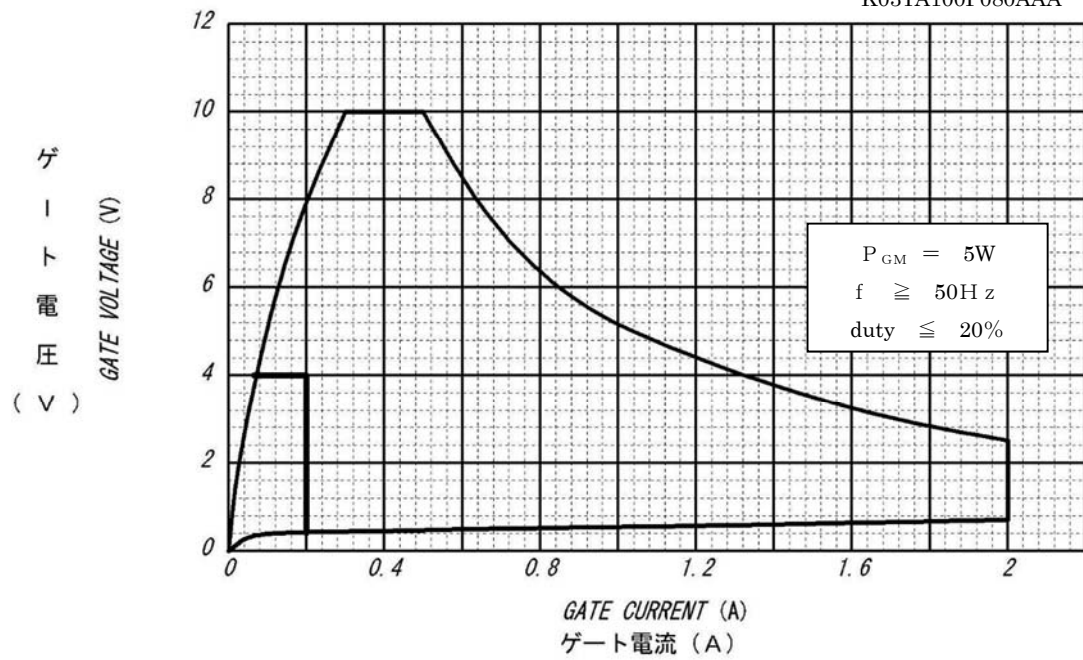

サージオン電流定格
SURGE CURRENT RATINGS

f=50Hz, Half Sine Wave, Non-Repetitive, On Load

K03TA100P080AAA Per 1 Arm.

サ
ー
ジ
オ
ン
電
流
(A)

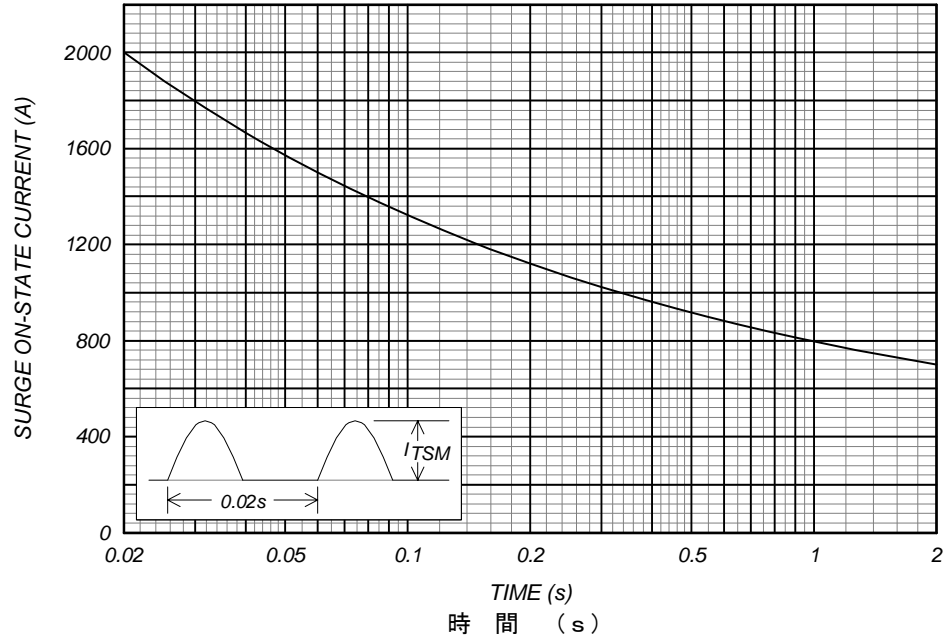

過渡熱抵抗特性
Transient Thermal Impedance

K03TA100P080AAA Per 1 Arm.

過
渡
熱
抵
抗
(°C/W)

