

### General Description

The QPD1008L is a 125 W ( $P_{3dB}$ ) wideband unmatched discrete GaN on SiC HEMT which operates from DC to 3.2 GHz with a 50V supply rail. The device is in an industry standard air cavity package and is ideally suited for military and civilian radar, land mobile and military radio communications, avionics, and test instrumentation. The device can support pulsed, CW, and linear operation.

Lead-free and ROHS compliant

Evaluation boards are available upon request.



### Functional Block Diagram

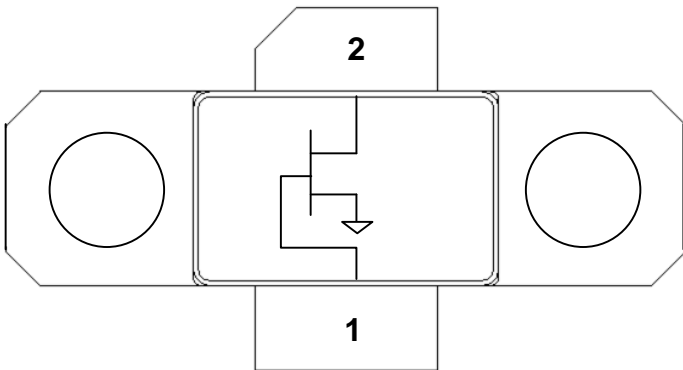

### Product Features

- Frequency: DC to 3.2 GHz
  - Output Power ( $P_{3dB}$ )<sup>1</sup>: 162 W
  - Linear Gain<sup>1</sup>: 17.5 dB
  - Typical  $DEFF_{3dB}$ <sup>1</sup>: 74%
  - Operating Voltage: 50 V
  - Low thermal resistance package
  - CW and Pulse capable
- Note: 1 @ 2 GHz

### Applications

- Military radar
- Civilian radar
- Land mobile and military radio communications
- Test instrumentation
- Wideband or narrowband amplifiers
- Jammers
- Avionics

Part No.	Description
QPD1008L	DC – 3.2 GHz RF Transistor
QPD1008LPCB4B01	0.96 – 1.215 GHz EVB
QPD1008LEVB2	1.1 – 1.5 GHz EVB

### Absolute Maximum Ratings

Parameter	Rating
Drain to Gate Voltage ( $V_{DG}$ )	145 V
Gate Voltage Range ( $V_G$ )	-7 to +2 V
RF Input Power, CW, 50 $\Omega$ , T = 25 °C	40 dB
Power Dissipation $P_{DISS}$	See graph on page 5
Storage Temperature	-65 to 150°C

Exceeding any one or a combination of the Absolute Maximum Rating conditions may cause permanent damage to the device. Extended application of Absolute Maximum Rating conditions to the device may reduce device reliability.

### Recommended Operating Conditions

Parameter	Min	Typ	Max	Unit
Drain Voltage ( $V_D$ )	+12	+48	+55	V
Carrier Gate Voltage ( $V_G$ )		-2.8		V
Carrier Quiescent Current ( $I_{DQ1}$ )		260		mA
Operating Temperature Range	-40	+25	+85	°C

Electrical specifications are measured at specified test conditions. Specifications are not guaranteed over all recommended operating conditions.

Note:

- To be adjusted to desired  $I_{DQ}$

### Electrical Characterization

Symbol	Parameter	Min	Typical	Max	Units
Gate Leakage	$V_D = +10$ V, $V_G = -3.8$ V	-23.1			mA

### Pulsed Characterization – Load-Pull Performance – Power Tuned<sup>1</sup>

Parameters	Typical Values			Unit
	1	2	3	
Frequency, F	1	2	3	GHz
Linear Gain, $G_{LIN}$	22.5	17.5	14.1	dB
Output Power at 3dB compression point, $P_{3dB}$	52.0	52.1	51.9	dBm
Drain Efficiency at 3dB compression point, $DEFF_{3dB}$	63.4	62.1	59.2	%
Gain at 3dB compression point	19.5	14.4	11.1	dB

Notes:

1. Test conditions unless otherwise noted:  $V_D = +50\text{ V}$ ,  $I_D = 260\text{ mA}$ , Temp = +25 °C

### Pulsed Characterization – Load-Pull Performance – Efficiency Tuned<sup>1</sup>

Parameters	Typical Values			Unit
	1	2	3	
Frequency	1	2	3	GHz
Linear Gain, $G_{LIN}$	23.5	18.6	15.2	dB
Output Power at 3dB compression point, $P_{3dB}$	48.2	50.2	51.0	dBm
Drain Efficiency at 3dB compression point, $DEFF_{3dB}$	76.2	74.6	69.7	%
Gain at 3dB compression point, $G_{3dB}$	20.5	15.6	12.2	dB

Notes:

1. Test conditions unless otherwise noted:  $V_D = +50\text{ V}$ ,  $I_{DQ} = 260\text{ mA}$ , Temp = +25 °C

### RF Characterization – EVB1 Performance at 1.09 GHz<sup>1</sup>

Parameter	Min	Typ	Max	Units
Linear Gain, $G_{LIN}$	–	20	–	dB
Output Power at 3dB compression point, $P_{3dB}$	–	51.2	–	dBm
Drain Efficiency at 3dB compression point, $DEFF_{3dB}$	–	73.5	–	%
Gain at 3dB compression point, $G_{3dB}$	–	17	–	dB

Notes:

1.  $V_D = +50\text{ V}$ ,  $I_{DQ} = 260\text{ mA}$ , Temp = +25 °C, Pulse Width = 128  $\mu\text{s}$ , Duty Cycle = 10%

### RF Characterization – Mismatch Ruggedness at 1.09 GHz

Symbol	Parameter	dB Compression	Typical
VSWR	Impedance Mismatch Ruggedness	3	10:1

Test conditions unless otherwise noted:  $T_A = 25\text{ °C}$ ,  $V_D = 50\text{ V}$ ,  $I_{DQ} = 260\text{ mA}$

Driving input power is determined at pulsed 3dB compression under matched condition at EVB output connector.

**Thermal and Reliability Information - CW <sup>(1)</sup>**

Parameter	Test Conditions	Value	Units
Thermal Resistance, Peak IR Surface Temperature at Average Power ( $\theta_{JC}$ )	$P_{DISS} = 21\text{ W}$ , $T_{baseplate} = 85^\circ\text{C}$	1.24	$^\circ\text{C/W}$
Channel Temperature, $T_{CH}$		111	$^\circ\text{C}$
Thermal Resistance, Peak IR Surface Temperature at Average Power ( $\theta_{JC}$ )	$P_{DISS} = 42\text{ W}$ , $T_{baseplate} = 85^\circ\text{C}$	1.33	$^\circ\text{C/W}$
Channel Temperature, $T_{CH}$		141	$^\circ\text{C}$
Thermal Resistance, Peak IR Surface Temperature at Average Power ( $\theta_{JC}$ )	$P_{DISS} = 63\text{ W}$ , $T_{baseplate} = 85^\circ\text{C}$	1.41	$^\circ\text{C/W}$
Channel Temperature, $T_{CH}$		174	$^\circ\text{C}$
Thermal Resistance, Peak IR Surface Temperature at Average Power ( $\theta_{JC}$ )	$P_{DISS} = 84\text{ W}$ , $T_{baseplate} = 85^\circ\text{C}$	1.51	$^\circ\text{C/W}$
Channel Temperature, $T_{CH}$		212	$^\circ\text{C}$
Thermal Resistance, Peak IR Surface Temperature at Average Power ( $\theta_{JC}$ )	$P_{DISS} = 105\text{ W}$ , $T_{baseplate} = 85^\circ\text{C}$	1.6	$^\circ\text{C/W}$
Channel Temperature, $T_{CH}$		253	$^\circ\text{C}$

**Notes:**

1. Thermal resistance measured to bottom of package.
2. Refer to the following document: [GaN Device Channel Temperature, Thermal Resistance, and Reliability Estimates](#)

**Thermal and Reliability Information - Pulsed <sup>(1)</sup>**

Parameter	Test Conditions	Value	Units
Thermal Resistance, Peak IR Surface Temperature at Average Power ( $\theta_{JC}$ )	$P_{DISS} = 42\text{ W}$ , $T_{baseplate} = 85^\circ\text{C}$ Pulse Width = 128 $\mu\text{S}$	0.74	$^\circ\text{C/W}$
Channel Temperature, $T_{CH}$		Duty Cycle = 10%	116
Thermal Resistance, Peak IR Surface Temperature at Average Power ( $\theta_{JC}$ )	$P_{DISS} = 63\text{ W}$ , $T_{baseplate} = 85^\circ\text{C}$ Pulse Width = 128 $\mu\text{S}$	0.76	$^\circ\text{C/W}$
Channel Temperature, $T_{CH}$		Duty Cycle = 10%	133
Thermal Resistance, Peak IR Surface Temperature at Average Power ( $\theta_{JC}$ )	$P_{DISS} = 84\text{ W}$ , $T_{baseplate} = 85^\circ\text{C}$ Pulse Width = 128 $\mu\text{S}$	0.77	$^\circ\text{C/W}$
Channel Temperature, $T_{CH}$		Duty Cycle = 10%	150
Thermal Resistance, Peak IR Surface Temperature at Average Power ( $\theta_{JC}$ )	$P_{DISS} = 105\text{ W}$ , $T_{baseplate} = 85^\circ\text{C}$ Pulse Width = 128 $\mu\text{S}$	0.80	$^\circ\text{C/W}$
Channel Temperature, $T_{CH}$		Duty Cycle = 10%	169
Thermal Resistance, Peak IR Surface Temperature at Average Power ( $\theta_{JC}$ )	$P_{DISS} = 126\text{ W}$ , $T_{baseplate} = 85^\circ\text{C}$ Pulse Width = 128 $\mu\text{S}$	0.82	$^\circ\text{C/W}$
Channel Temperature, $T_{CH}$		Duty Cycle = 10%	188

**Notes:**

1. Thermal resistance measured to bottom of package.
2. Refer to the following document: [GaN Device Channel Temperature, Thermal Resistance, and Reliability Estimates](#)

## Maximum Channel Temperature

---

Peak IR Surface Temperature vs. CW Dissipation Power

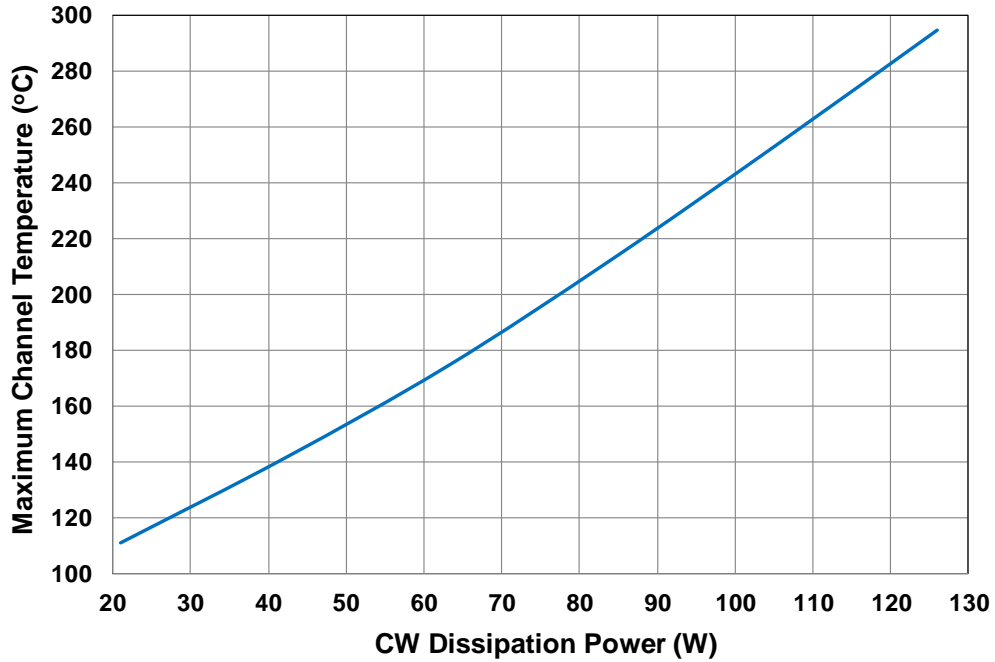

Peak IR Surface Temperature vs. CW Dissipation Power

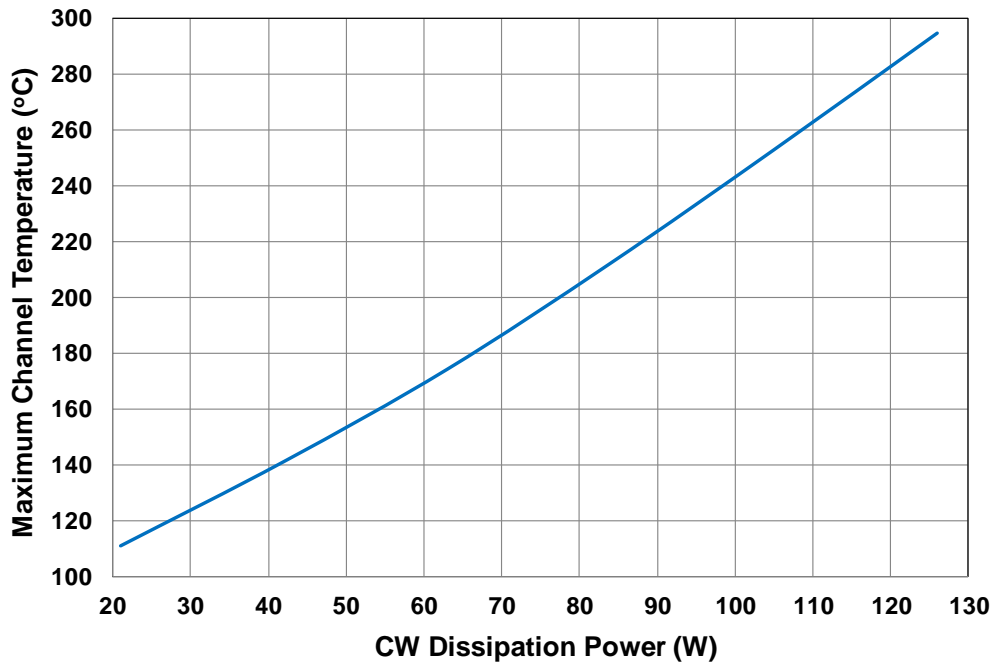

## Load-Pull Smith Charts<sup>1, 2</sup>

Notes:

- 50 V, 260 mA, Pulsed signal with 128 uS pulse width and 10 % duty cycle.
- See page 13 for load-pull and source-pull reference planes. 11.7-Ω load-pull TRL fixtures are built with 32-mil RO4360G2 material.

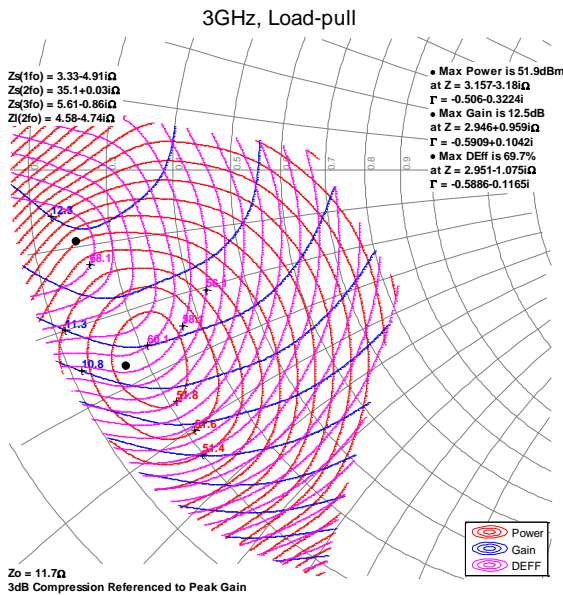
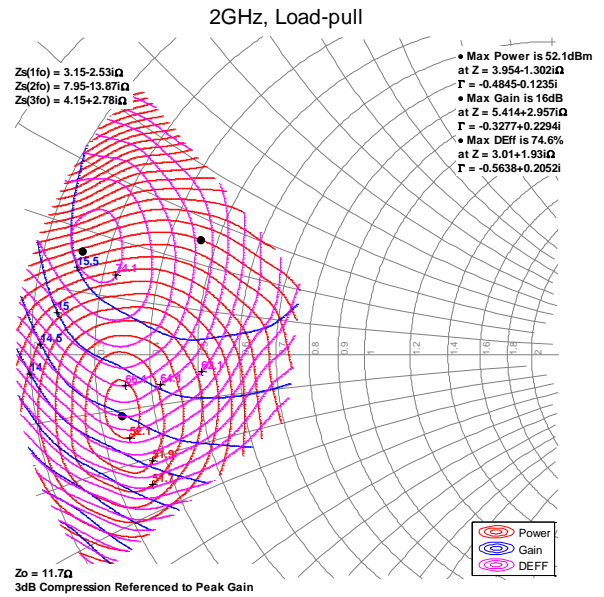
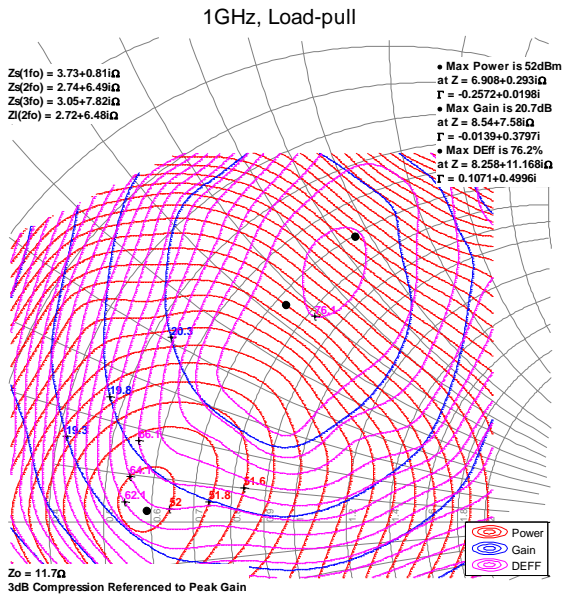

### Typical Performance – Load-Pull Drive-up

Notes:

1. Pulsed signal with 128 uS pulse width and 10 % duty cycle,  $V_d = 50\text{ V}$ ,  $I_{DQ} = 260\text{ mA}$ .
2. See page 13 for load-pull and source-pull reference planes where the performance was measured.

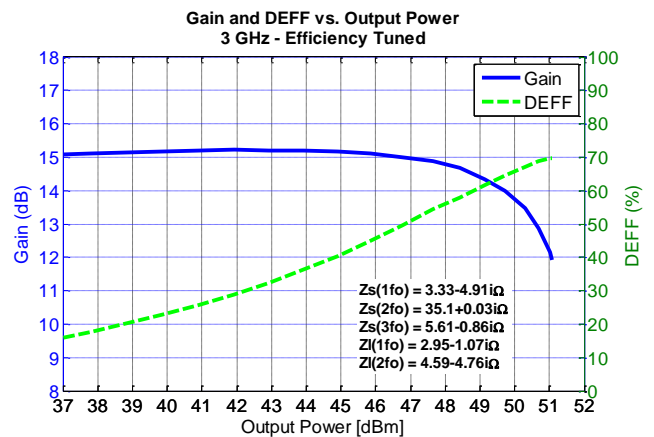
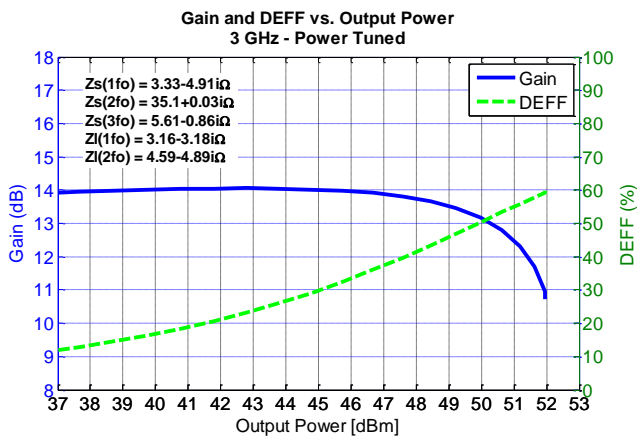
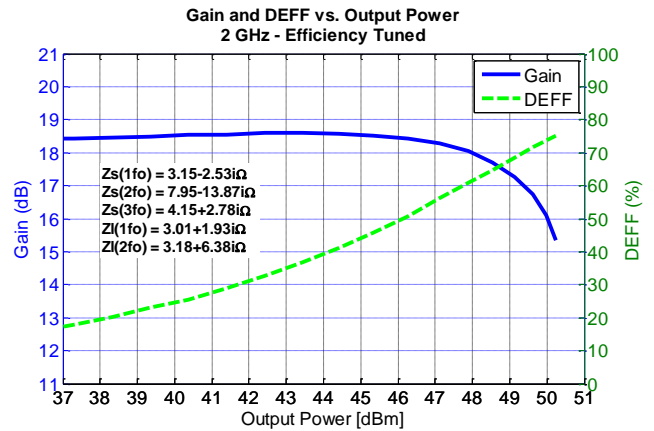
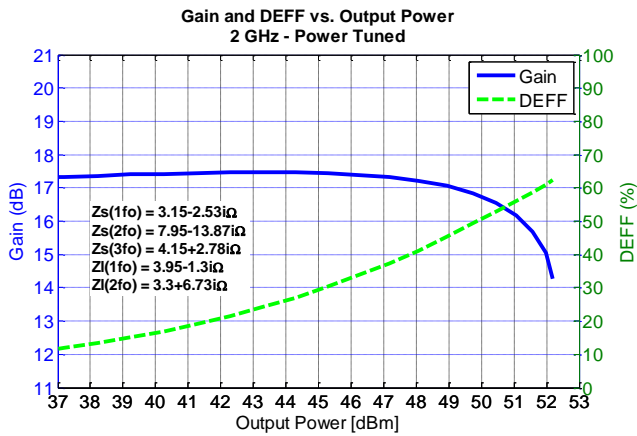
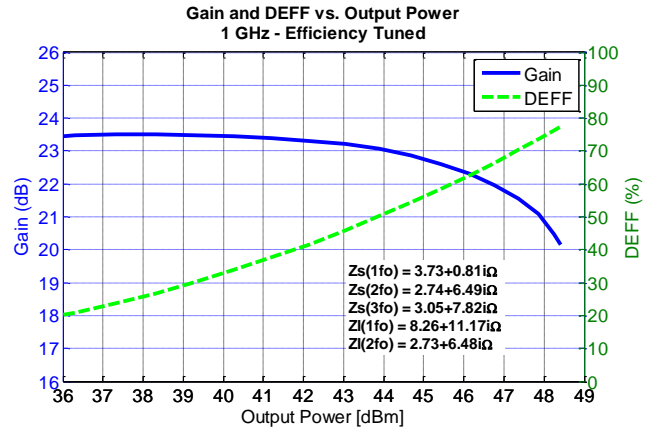
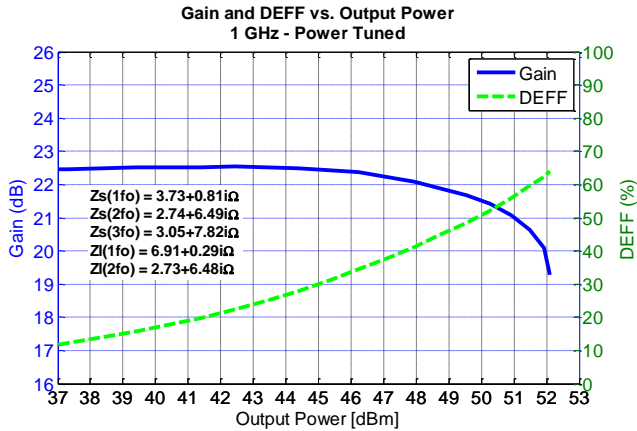

### Power Driveup Performance Over Temperatures Of 0.96 – 1.215 GHz EVB<sup>1</sup>

Notes:

1. Pulsed signal with 128 uS pulse width and 10 % duty cycle,  $V_d = 50\text{ V}$ ,  $I_{DQ} = 260\text{ mA}$ .

**P3dB Over Temperatures**

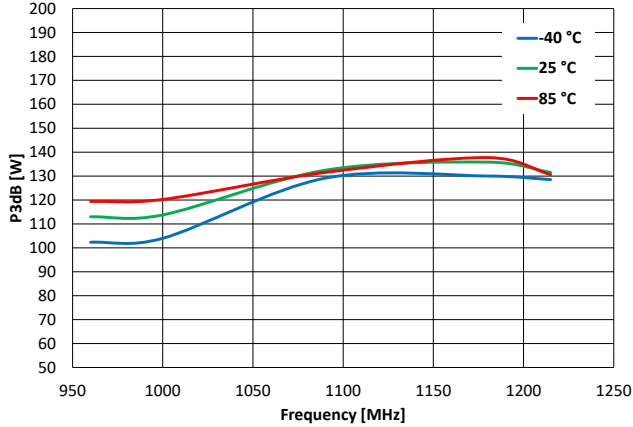

**DEFF3dB Over Temperatures**

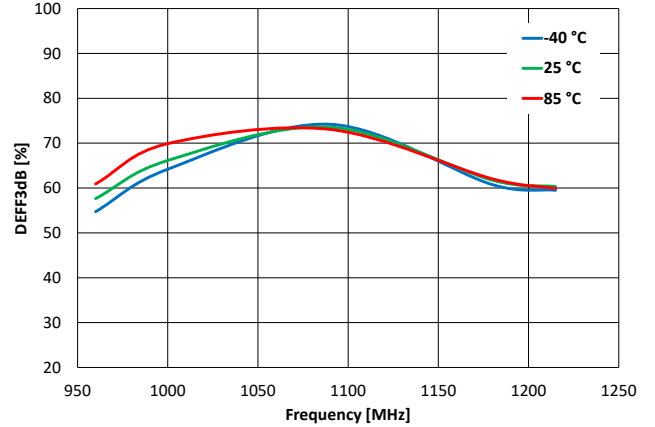

**G3dB Over Temperatures**

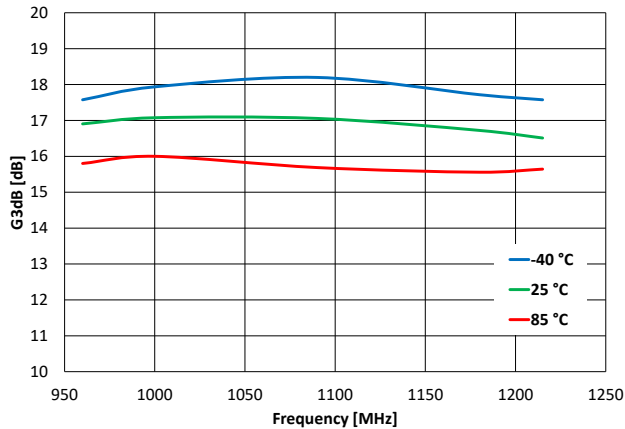

**Pdiss3dB Over Temperatures**

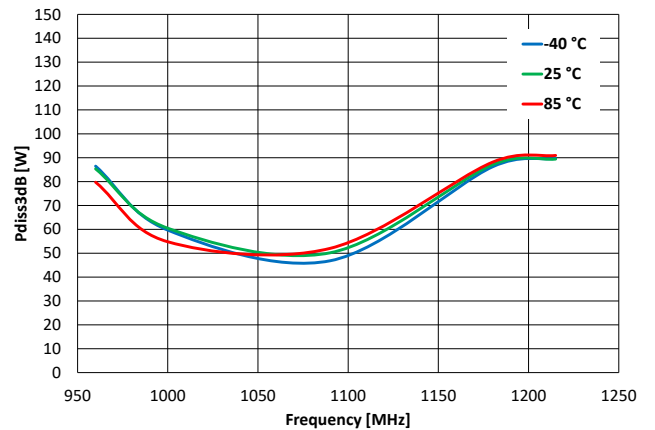



### Typical Performance – 0.96 – 1.215 GHz EVB at 25 °C <sup>1</sup>

Notes:

1. Pulsed signal with 128 uS pulse width and 10 % duty cycle,  $V_d = 50\text{ V}$ ,  $I_{DQ} = 260\text{ mA}$

**P3dB At 25 °C**

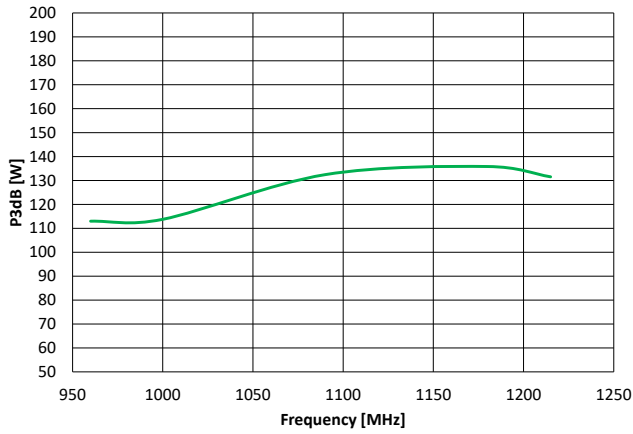

**DEFF3dB At 25 °C**

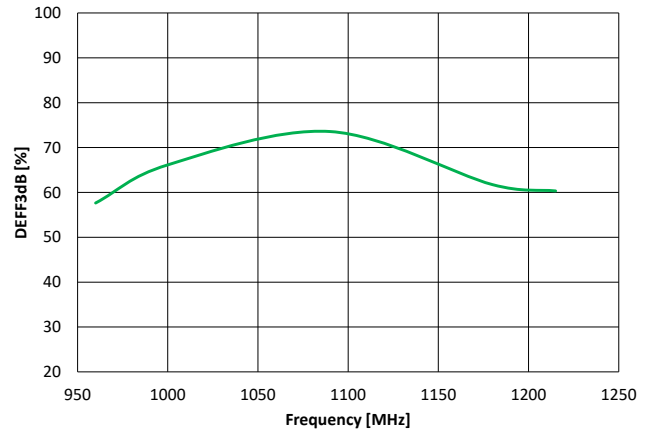

**G3dB At 25 °C**

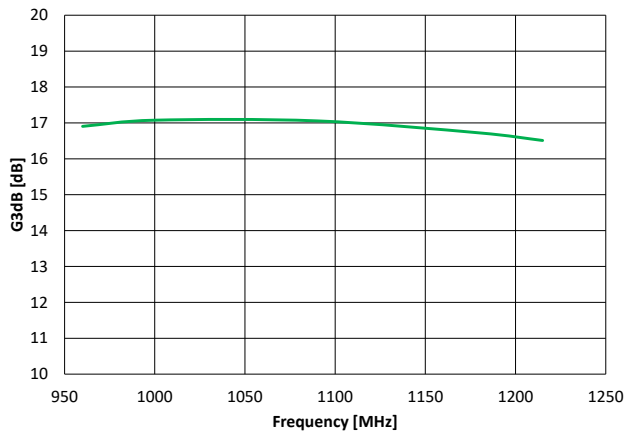

**Pdiss3dB At 25 °C**

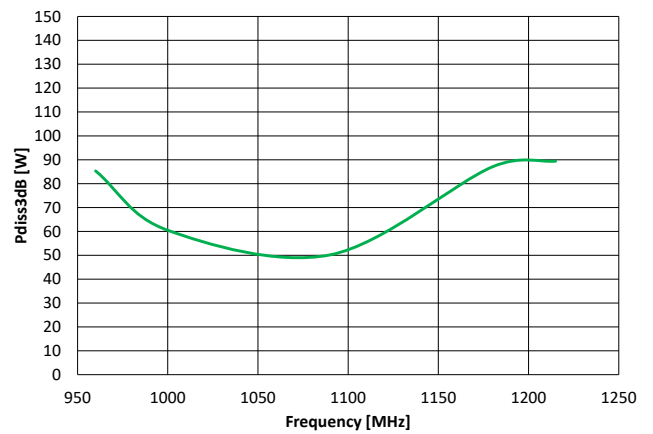

### Typical 2-Tone Performance – 0.96 – 1.215 GHz EVB at 25 °C <sup>1</sup>

Notes:

- Center Frequency = 1.095 GHz, Tone Spacing = 10 MHz, I<sub>BQ</sub> = 260 mA and 520 mA.

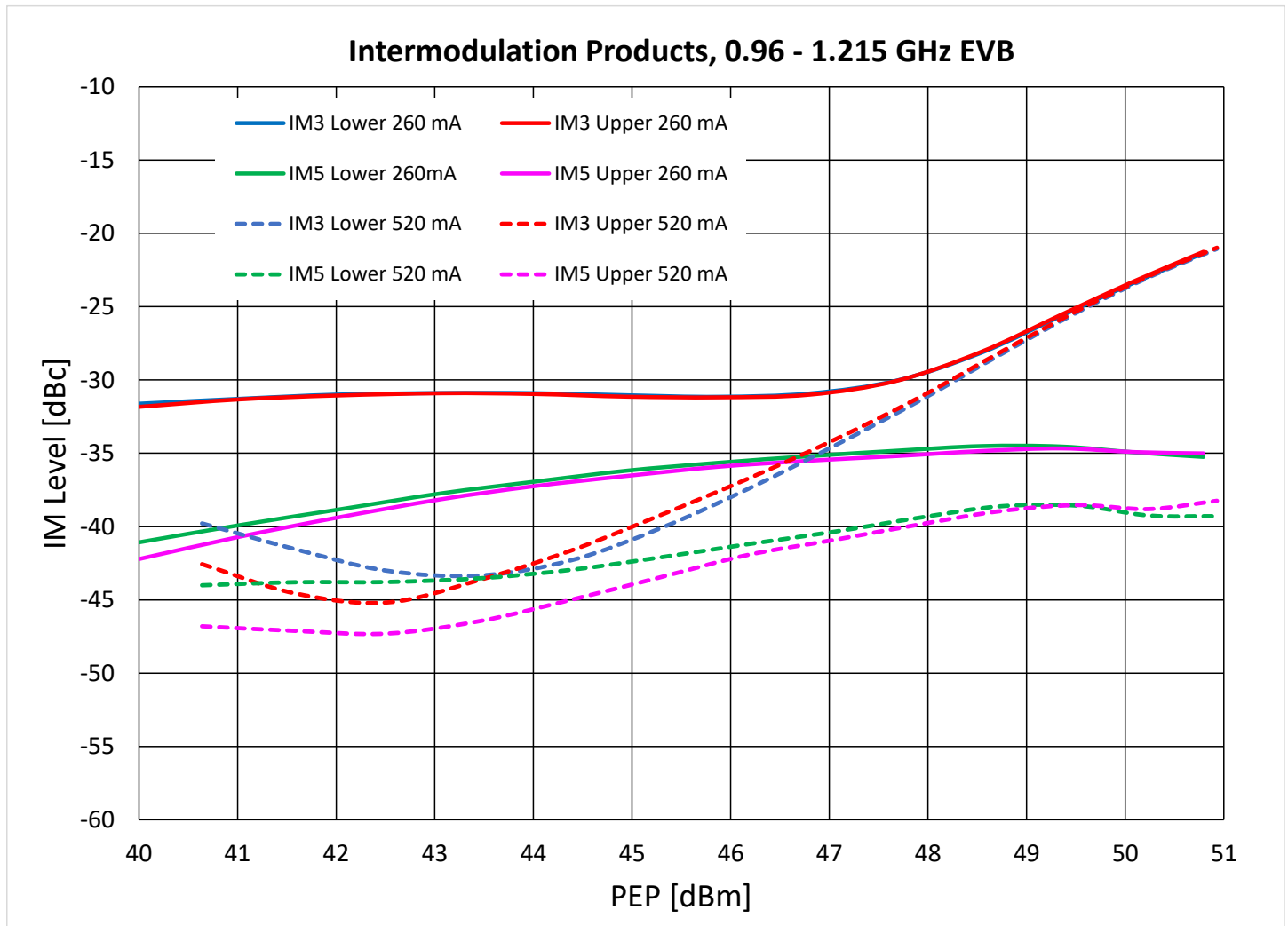

### Typical Performance – 1.1 – 1.5 GHz EVB at 25 °C <sup>1</sup>

Notes:

1. Pulsed signal with 128 uS pulse width and 10 % duty cycle,  $V_d = 50\text{ V}$ ,  $I_{DQ} = 260\text{ mA}$ .

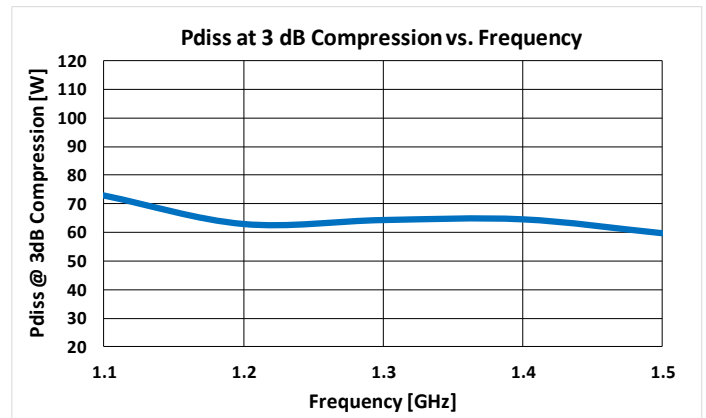
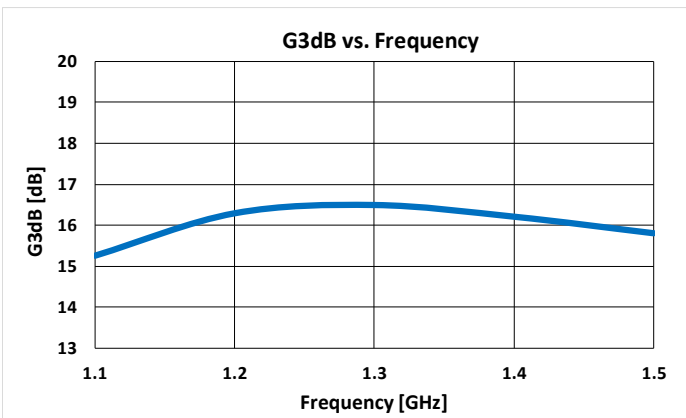
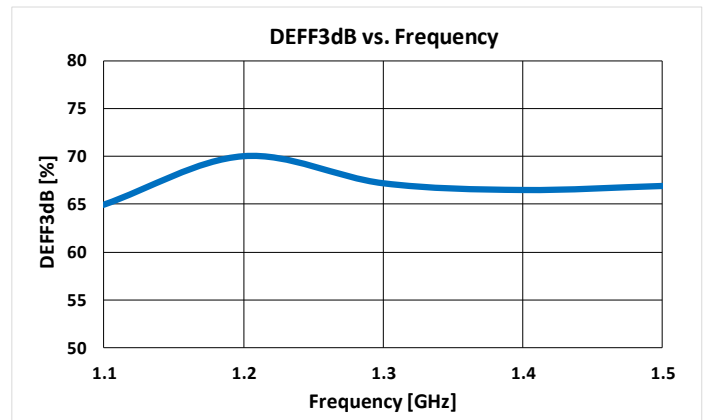
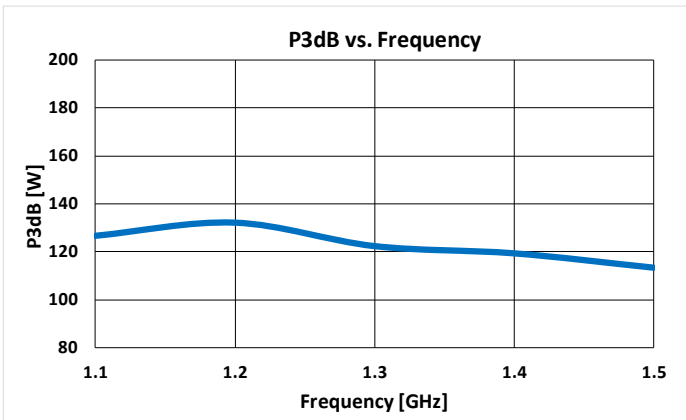

## Pin Layout<sup>1</sup>

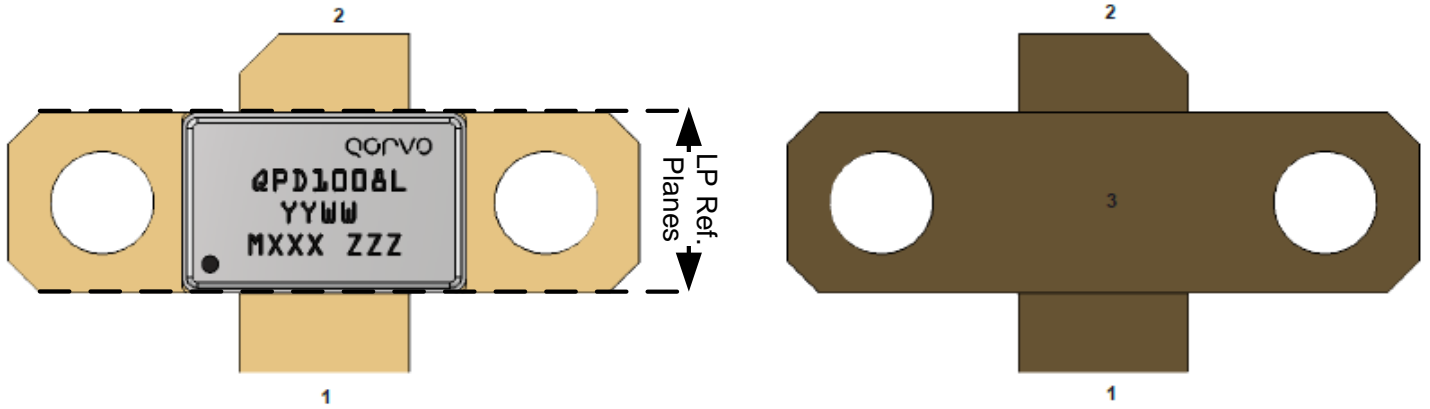

**Notes:**

- The QPD1008L will be marked with the “QPD1008L” designator and a lot code marked below the part designator. The “YY” represents the last two digits of the calendar year the part was manufactured, the “WW” is the work week of the assembly lot start, the “MXXX” is the production lot number, and the “ZZZ” is an auto-generated serial number.

## Pin Description

Pin	Symbol	Description
1	VG / RF IN	Gate voltage / RF Input
2	VD / RF OUT	Drain voltage / RF Output
3	Flange	Source to be connected to ground

## Mechanical Drawing<sup>1</sup>

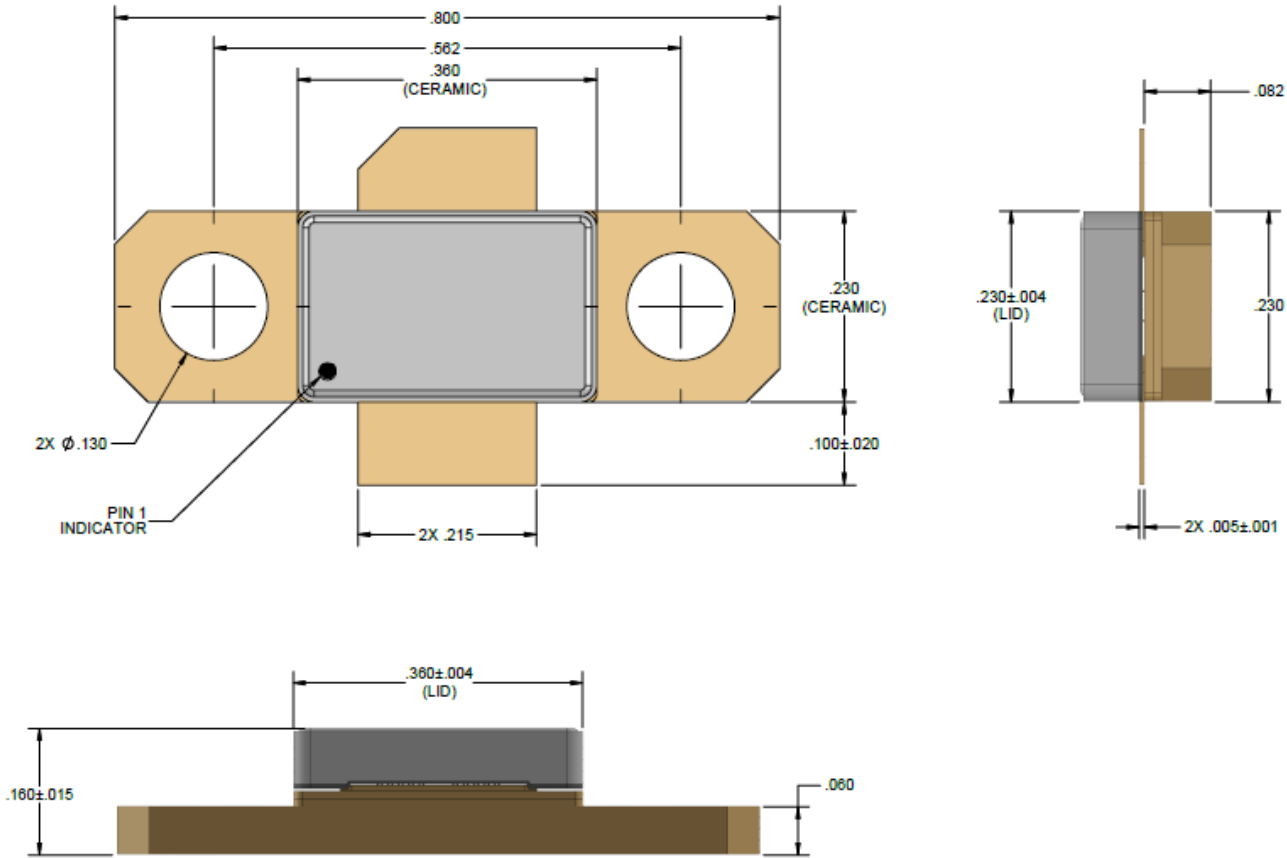

### Note 1:

1. All dimensions are in inches. Angles are in degrees.
2. Dimension tolerance is  $\pm 0.005$  inches, unless otherwise noted.
3. Material:  
 Package Base: Ceramic / Metal  
 Package Lid: Ceramic
4. Package exposed metallization is gold plated.
5. Part is epoxy sealed.
6. Part meets industry NI360 footprint.
7. Body dimensions do not include epoxy runout which can be up to 0.020 inches per side.

## 0.96 – 1.215 GHz Application Circuit - Schematic

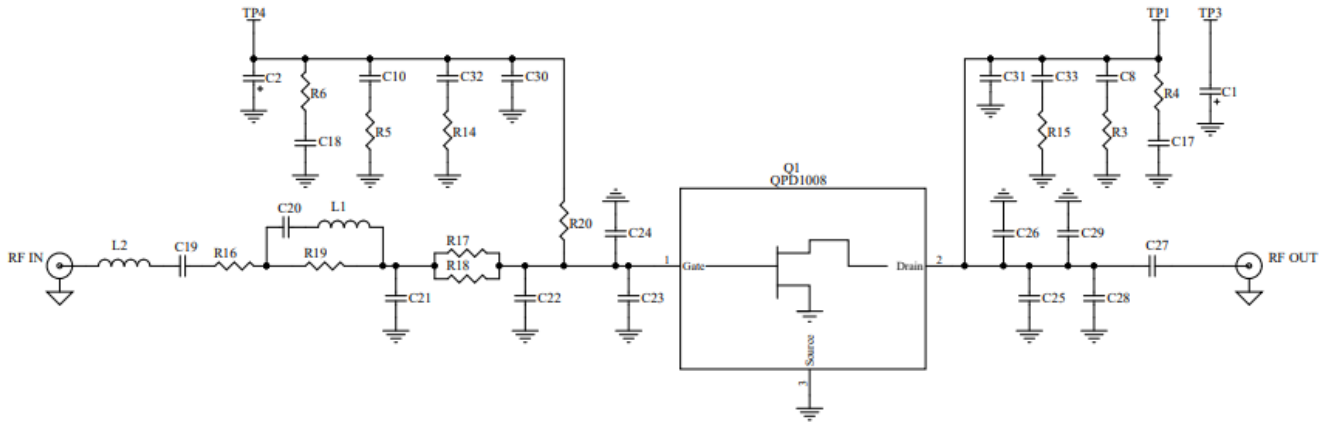

Bias-up Procedure	Bias-down Procedure
1. Set $V_G$ to -4 V.	1. Turn off RF signal.
2. Set $I_D$ current limit to 300 mA.	2. Turn off $V_D$
3. Apply 50 V $V_D$ .	3. Wait 2 seconds to allow drain capacitor to discharge
4. Slowly adjust $V_G$ until $I_D$ is set to 260 mA.	4. Turn off $V_G$
5. Set $I_D$ current limit to 0.6 A (Pulsed operation)	
6. Apply RF.	

## 0.96 – 1.215 GHz Application Circuit - Layout

Board material is RO4360G2 0.032" thickness with 1oz copper cladding.

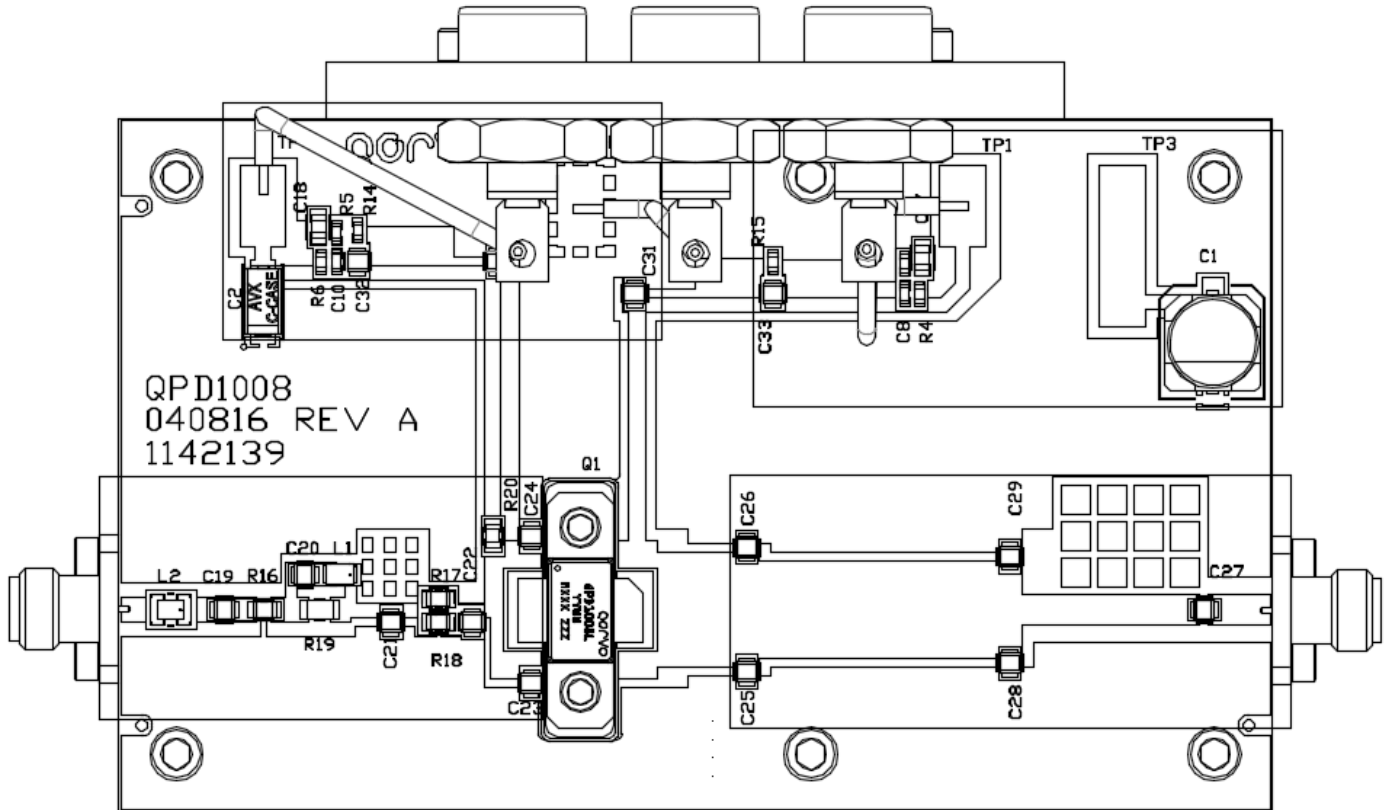

**0.96 – 1.215 GHz Application Circuit - Bill Of material**

Ref Des	Value	Description	Manufacturer	Part Number
C8, 10	1 nF	X7R 100V 5% 0603 Capacitor	AVX	06031C102JAT2A
C17 - 18	100 nF	X7R 100V 5% 0805 Capacitor	AVX	08051C104JAT2A
C28 - 29	2 pF	RF NPO 250VDC ± 0.1 pF Capacitor	AVX	800A2R0BT250XT
C23 – 24	2.4 pF	RF NPO 250VDC ± 0.1 pF Capacitor	AVX	800A2R4BT250XT
C20	3.0 pF	RF NPO 250VDC ± 0.1 pF Capacitor	AVX	800A3R0BT250X
C21	4.7pF	RF NPO 250VDC ± 0.1 pF Capacitor	AVX	800A4R7BT250XT
C25, 26	6.2 pF	RF NPO 250VDC ± 0.1 pF Capacitor	Passive Plus	0505C6R2BW301X
C22	13 pF	RF NPO 250VDC 1% Capacitor	AVX	800A100FT250X
C19, 27, 30, 31	56 pF	RF NPO 250VDC 1% Capacitor	Passive Plus	0505C560FW151X
C32, 33	100 pF	RF NPO 250VDC 1% Capacitor	Passive Plus	0505C101FW151X
C1	33 uF	RF NPO 250VDC 1% Capacitor	Panasonic	63SXV33M
C2	10 uF	RF NPO 250VDC 1% Capacitor	AVX	TPSC106KR0500
J1 - 2		SMA Panel Mount 4-hole Jack	Gigalane	PSF-S00-000
L1	5.6 nH	0805 5% Inductor	Coilcraft	0805CS-050XJE
L2	4.1 nH	0805 5% Inductor	Coilcraft	1008HQ-4N1X-LB
R4, 6	1 Ohm	0603 Thick Film Resistor	ANY	
R5	3.3 Ohm	0603 Thick Film Resistor	ANY	
R14, 15	5.1 Ohm	0603 Thick Film Resistor	ANY	
R16	4.0 Ohm	0805CS High Power Thick Film Resistor		ND3-0805CS4R00J
R3	33 Ohm	0603 Thick Film Resistor	ANY	
R20	3.9 Ohm	0805 Thick Film Resistor	ANY	
R17, 18	7 Ohm	0805CS High Power Thick Film Resistor	IMS	ND3-0805CS7R00J
R19	510 Ohm	1206 Thick Film Resistor	ANY	



### 1.1 – 1.5 GHz Application Circuit - Schematic

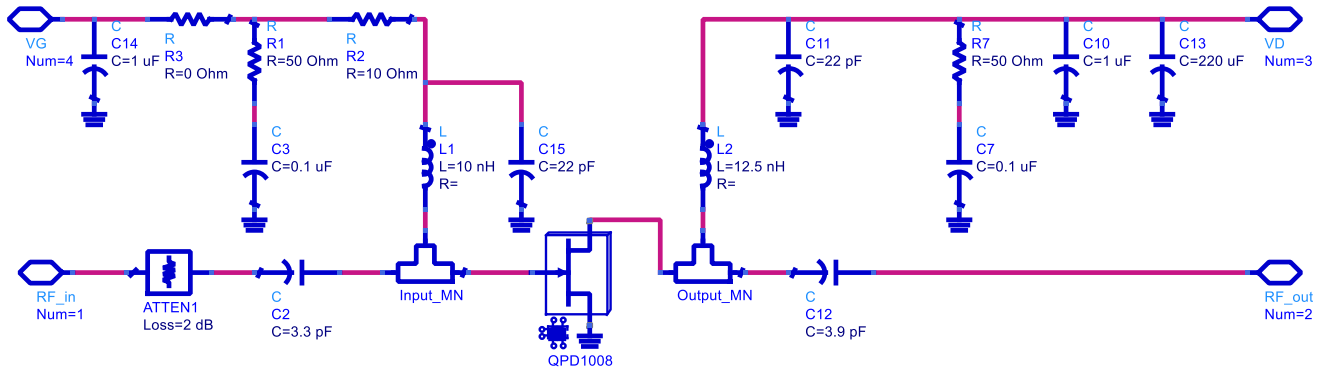

Bias-up Procedure	Bias-down Procedure
2. Set $V_G$ to -4 V.	3. Turn off RF signal.
4. Set $I_D$ current limit to 300 mA.	4. Turn off $V_D$
5. Apply 50 V $V_D$ .	5. Wait 2 seconds to allow drain capacitor to discharge
6. Slowly adjust $V_G$ until $I_D$ is set to 260 mA.	7. Turn off $V_G$
8. Set $I_D$ current limit to 0.6 A (Pulsed operation)	
9. Apply RF.	

### 1.1 – 1.5 GHz Application Circuit - Layout

Board material is RO4360G2 0.032" thickness with 1oz copper cladding. EVB dimension is 3" x 4".

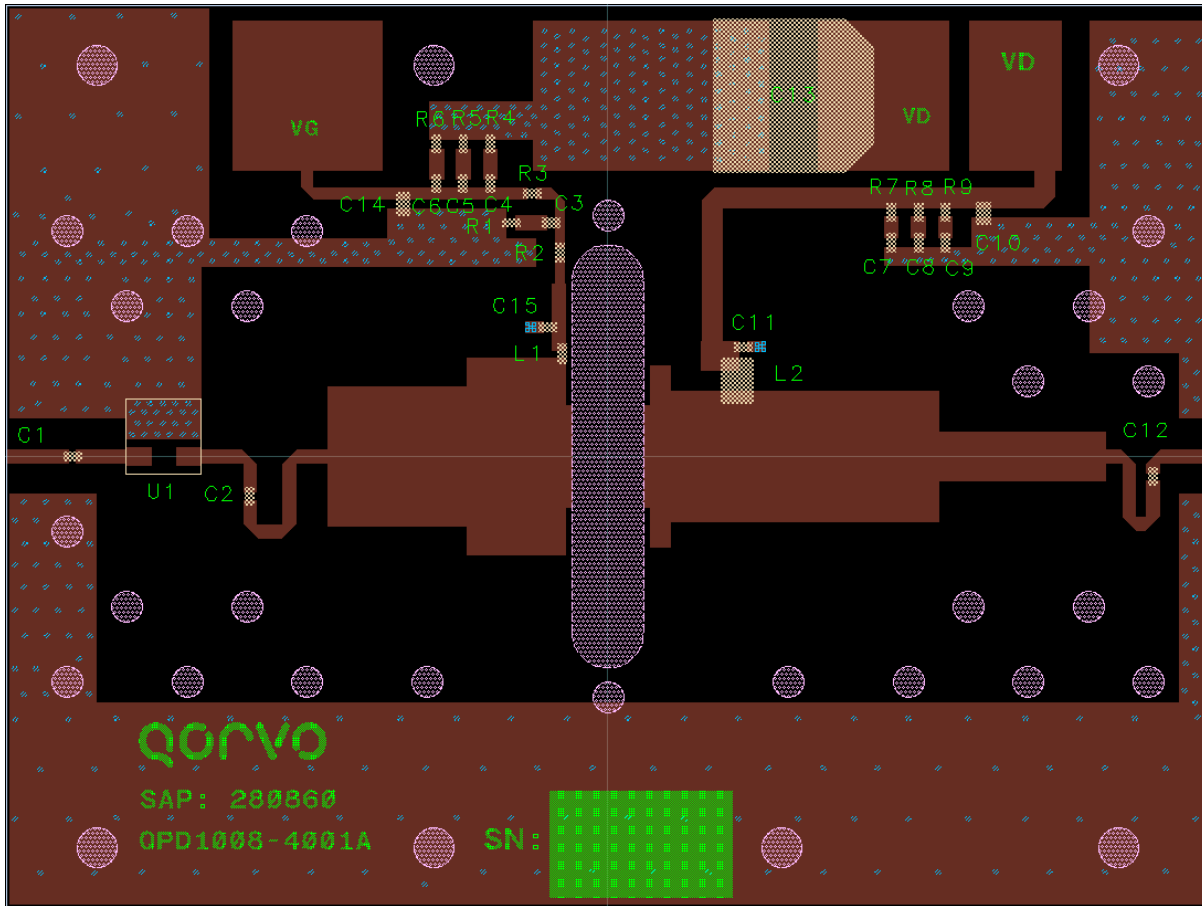

### 1.1 – 1.5 GHz Application Circuit - Bill Of material

Ref Des	Value	Quantity	Part Number	Manufacturer
C1	100 pF	1	0603G101J201S	Capax
C2	3.3 pF	1	600S3R3AT250XT	ATC
C12	3.9 pF	1	600S3R9AT250XT	ATC
C11, C15	22 pF	2	600S220FT250XT	ATC
C3, C7	0.1 uF	2	GRM188R72A104KA35D	Murata
C10, C14	1 uF	2	C2012X7S2A105M125AB	TDK
C13	100 uF, 63 V	1	EEETG1J101UP	Panasonic
R1, R7	50 Ohm	2	CRCW060350R0FKEA-ND	Vishay
R2	10 Ohm	1	CRCW060310R0JNEA	Vishay
L1	10 nH	1	0603CS-10NXJEW	Coilcraft
L2	12.5 nH	1	A04TJLC	Coilcraft
U1	2dB Atten.	1	RFP-250250-4AA2-1	Anaren

**Recommended Solder Temperature Profile**

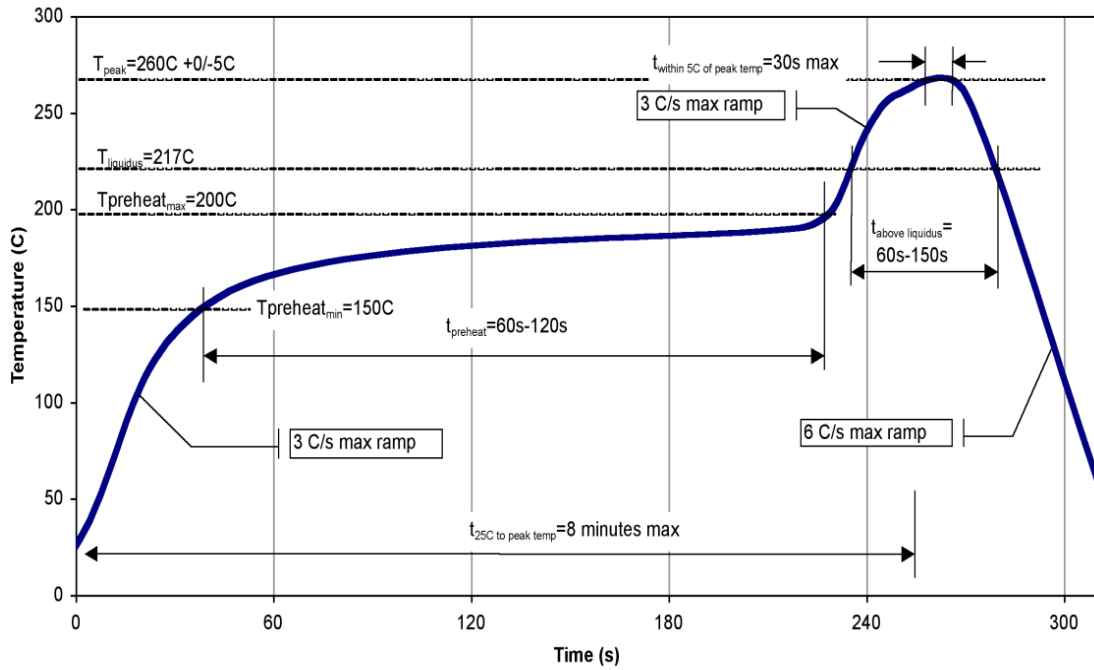

### Handling Precautions

Parameter	Rating	Standard
ESD – Human Body Model (HBM)	Class 1A	ANSI/ESD/JEDEC JS-001
ESD – Charged Device Model (CDM)	Class C3	ANSI/ESD/JEDEC JS-002
MSL – Moisture Sensitivity Level	MSL3	IPC/JEDEC J-STD-020



Caution!  
ESD-Sensitive Device

### Solderability

Compatible with both lead-free (260°C max. reflow temp.) and tin/lead (245°C max. reflow temp.) soldering processes. Solder profiles available upon request.

Contact plating: NiAu. Au thickness is 60 microinches minimum.

### RoHS Compliance

This part is compliant with 2011/65/EU RoHS directive (Restrictions on the Use of Certain Hazardous Substances in Electrical and Electronic Equipment) as amended by Directive 2015/863/EU.

This product also has the following attributes:

- Lead Free
- Halogen Free (Chlorine, Bromine)
- Antimony Free
- TBBP-A (C<sub>15</sub>H<sub>12</sub>Br<sub>4</sub>O<sub>2</sub>) Free
- PFOS Free
- SVHC Free



### Contact Information

For the latest specifications, additional product information, worldwide sales and distribution locations:

- Web:** [www.qorvo.com](http://www.qorvo.com)
- Tel:** 1-844-890-8163
- Email:** [customer.support@qorvo.com](mailto:customer.support@qorvo.com)

### Important Notice

The information contained herein is believed to be reliable; however, Qorvo makes no warranties regarding the information contained herein and assumes no responsibility or liability whatsoever for the use of the information contained herein. All information contained herein is subject to change without notice. Customers should obtain and verify the latest relevant information before placing orders for Qorvo products. The information contained herein or any use of such information does not grant, explicitly or implicitly, to any party any patent rights, licenses, or any other intellectual property rights, whether with regard to such information itself or anything described by such information. **THIS INFORMATION DOES NOT CONSTITUTE A WARRANTY WITH RESPECT TO THE PRODUCTS DESCRIBED HEREIN, AND QORVO HEREBY DISCLAIMS ANY AND ALL WARRANTIES WITH RESPECT TO SUCH PRODUCTS WHETHER EXPRESS OR IMPLIED BY LAW, COURSE OF DEALING, COURSE OF PERFORMANCE, USAGE OF TRADE OR OTHERWISE, INCLUDING THE IMPLIED WARRANTIES OF MERCHANTABILITY AND FITNESS FOR A PARTICULAR PURPOSE.**

Without limiting the generality of the foregoing, Qorvo products are not warranted or authorized for use as critical components in medical, life-saving, or life-sustaining applications, or other applications where a failure would reasonably be expected to cause severe personal injury or death.

Copyright 2021 © Qorvo, Inc. | Qorvo is a registered trademark of Qorvo, Inc.