

采用 3.8mm × 3mm 封装的 LMZM23600 36V、0.5A 降压直流/直流电源模块

1 特性

- 4V 至 36V 宽工作输入电压范围
- 1.2V 至 15V 可调输出电压和 3.3V 或 5V 固定输出电压选项
- 0.5A 输出电流
- 5V 和 3.3V 输出设计仅需要输入和输出电容器
- 27mm² 解决方案尺寸, 使用单面布局
- 28μA 无负载电源电流
- 2μA 关断电流
- 电源正常状态标志
- 外部频率同步
- 模式选择引脚
 - 强制 PWM 模式可实现恒定频率操作
 - 在轻负载条件下可实现高效率的自动 PFM 模式
- 内置控制环路补偿、软启动、电流限制和 UVLO
- 微型 3.8mm × 3mm × 1.6mm 封装
- 使用 LMZM23600 并借助 [WEBENCH®](#) 电源设计器创建定制设计

2 应用

- 传感器变送器
- 测试和测量
- 电网基础设施
- 空间受限型应用

3 说明

LMZM23600 集成电感器电源模块专为空间受限的工业应用。该器件提供 5V 和 3.3V 两种固定输出电压以及支持 1.2V 至 15V 范围的可调 (ADJ) 输出电压选项。LMZM23600 具有 4V 至 36V 的输入电压范围, 可提供高达 500mA 的输出电流。该电源模块使用起来极其简单, 5V 或 3.3V 输出设计只需 2 个外部组件。LMZM23600 的所有方面均针对空间受限的、性能驱动型低 EMI 工业应用进行了优化。漏极开路电源正常输出提供了系统状态的真实指示, 无需使用附加监控组件, 从而节省了成本和布板空间。PWM 和 PFM 模式之间的无缝转换以及仅 28μA 的无负载电源电流可确保实现整个负载电流范围的高效率和出色的瞬态响应。为了方便进行输出电流调节, LMZM23600 与支持 1000mA 输出电流的 LMZM23601 之间实现了引脚对引脚兼容。

器件信息(1)

器件型号	封装	封装尺寸 (标称值)
LMZM23600	MicroSiP™(10)	3.80mm × 3.00mm

(1) 如需了解所有可用封装, 请参阅数据表末尾的可订购产品附录。

固定输出选项的原理图
24V 至 5V、0.5A 直流/直流转换器

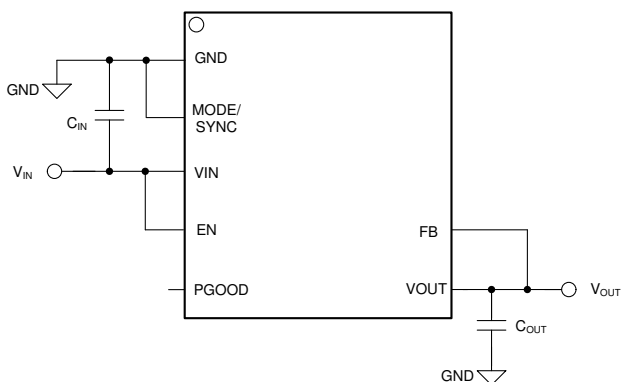

Copyright © 2017, Texas Instruments Incorporated

单面布局解决方案尺寸
24V 至 5V、0.5A 直流/直流转换器

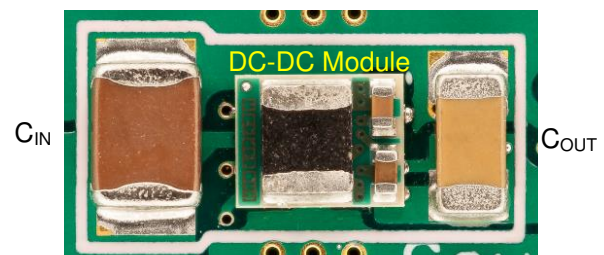

目录

1	特性	1	9.1	Application Information.....	22
2	应用	1	9.2	Typical Applications	22
3	说明	1	9.3	Do's and Don't's	34
4	修订历史记录	2	10	Power Supply Recommendations	35
5	Device Comparison	3	10.1	Supply Voltage Range	35
6	Pin Configuration and Functions	4	10.2	Supply Current Capability	35
7	Specifications	5	10.3	Supply Input Connections	35
7.1	Absolute Maximum Ratings	5	11	Layout	36
7.2	ESD Ratings.....	5	11.1	Layout Guidelines	36
7.3	Recommended Operating Conditions.....	5	11.2	Layout Examples.....	37
7.4	Thermal Information	5	12	器件和文档支持	39
7.5	Electrical Characteristics.....	6	12.1	器件支持	39
7.6	System Characteristics	9	12.2	使用 WEBENCH® 工具创建定制设计	39
7.7	Typical Characteristics	10	12.3	文档支持	39
8	Detailed Description	16	12.4	接收文档更新通知	39
8.1	Overview	16	12.5	社区资源	39
8.2	Functional Block Diagram	16	12.6	商标	40
8.3	Feature Description.....	16	12.7	静电放电警告.....	40
8.4	Device Functional Modes.....	21	12.8	Glossary	40
9	Application and Implementation	22	13	机械、封装和可订购信息	40
			13.1	Tape and Reel Information	40

4 修订历史记录

注：之前版本的页码可能与当前版本有所不同。

Changes from Revision A (April 2018) to Revision B	Page
• 已更改 将最小可调输出范围从 2.5V 更改为 1.2V	1
• 已添加 Maximum input voltage vs output voltage graph for $V_{OUT} < 2.5\text{ V}$, Power dissipation and Output current vs ambient temperature graphs for 1.2-V and 1.8-V outputs.....	10
• 已添加 information on maximum input voltage for $V_{OUT} < 2.5\text{ V}$	23
• 已添加 output capacitance requirements for 1.2-V and 1.8-V outputs	24
• 已添加 guidance on feedback resistor values for lower output voltages	25
• 已添加 typical application curves for 1.2-V and 1.8-V outputs	27

Changes from Original (February 2018) to Revision A	Page
• 首次发布生产数据数据表；添加 WEBENCH 链接.....	1

5 Device Comparison

Table 1. LMZM23600 Device Options

PART NUMBER	OUTPUT VOLTAGE	PACKAGE QTY ⁽¹⁾
LMZM23600SILR	Adjustable	3000
LMZM23600V3SILR	3.3 V	3000
LMZM23600V5SILR	5 V	3000
LMZM23600SILT	Adjustable	250
LMZM23600V3SILT	3.3 V	250
LMZM23600V5SILT	5 V	250

(1) See Package Option Addendum for tape and reel details as well as links used to order parts.

6 Pin Configuration and Functions

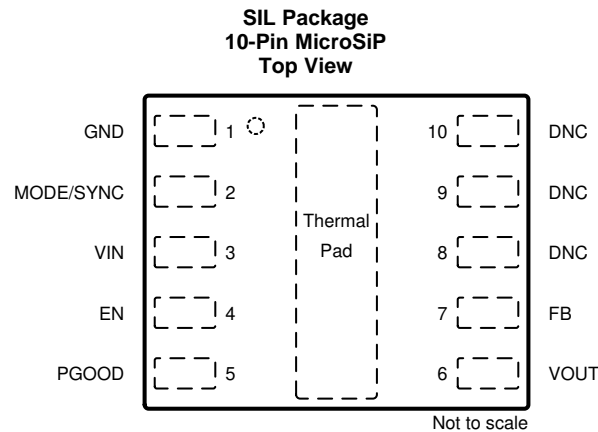

Pin Functions

PIN		TYPE	DESCRIPTION
NO.	NAME		
1	GND	G	Ground for all circuitry. Reference point for all voltages.
2	MODE/SY NC	I	This is a multifunction mode control input which is tolerant of voltages up to the input voltage. With this input tied LOW, the device is in Auto PFM mode with automatic transition between PFM and PWM with diode emulation at light load. This mode is recommended when the application requires high efficiency at light load. With this input tied HIGH, the device is in forced PWM mode. The device switches at the internal clock frequency. This mode is recommended when the application requires constant switching frequency across the entire load current. With a valid synchronization signal at this pin, the device switches in forced PWM mode at the external clock frequency and synchronized with it at the rising edge of the clock. Do not float this pin.
3	VIN	P	Input supply to the regulator. Connect a high-quality bypass capacitor(s) directly to this pin and the GND pin (pin 1).
4	EN	I	Enable input to the regulator. HIGH = ON, LOW = OFF. This pin can be connected to VIN. Do not float.
5	PGOOD	O	Open-drain, power-good output. Connect to a suitable voltage supply through a current limiting resistor. HIGH = power is good, LOW = fault. This output terminal is LOW when EN is LOW.
6	VOUT	O	Output voltage terminal. It is internally connected to one terminal of the integrated inductor. Connect an output filter capacitor from VOUT to GND and place the capacitor as close as possible to the VOUT pin.
7	FB	I	Feedback input to the regulator. If using the fixed 3.3-V or 5-V options of the device, connect this pin to the positive end of the output filter capacitor (the VOUT node). If using the adjustable output option of the device connect this to the feedback voltage divider and keep this node as small as possible on the board layout.
8	DNC	O	Do not connect. Leave floating. This pin provides access to the internal VCC voltage of the device.
9	DNC	O	Do not connect. Leave floating. This pin provides access to the internal BOOT voltage for the high side MOSFET driver.
10	DNC	O	Do not connect. Leave floating. This pin provides access to the internal SW voltage of the device.
Thermal Pad	—	G	This terminal is internally connected to GND and provides a wide thermal connection from the IC to the PCB. Connect to electrical ground plane for adequate heat sinking.

G = Ground, I = Input, O = Output, P = Power

7 Specifications

7.1 Absolute Maximum Ratings

over operating free-air temperature range (unless otherwise noted)⁽¹⁾

	MIN	MAX	UNIT
V _{IN} to GND	-0.3	42	V
SW to GND	-0.3	V _{IN} + 0.3	V
BOOT to SW	-0.3	3.6	V
EN to GND	-0.3	42	V
VO _{UT} to GND	-0.3	16	V
FB to GND (3.3-V and 5-V options)	-0.3	16	V
FB to GND (ADJ option)	-0.3	5.5	V
PGOOD to GND	-0.3	16	V
PGOOD sink current		8	mA
MODE/SYNC to GND	-0.3	42	V
VCC to GND	-0.3	3.6	V
Operating junction temperature, T _J	-40	125	°C
Storage temperature, T _{stg}	-40	150	°C

- (1) Stresses beyond those listed under Absolute Maximum Ratings may cause permanent damage to the device. These are stress ratings only, which do not imply functional operation of the device at these or any other conditions beyond those indicated under Recommended Operating Conditions. Exposure to absolute-maximum-rated conditions for extended periods may affect device reliability.

7.2 ESD Ratings

			VALUE	UNIT
V _(ESD)	Electrostatic discharge	Human body model (HBM), per ANSI/ESDA/JEDEC JS-001, all pins ⁽¹⁾	±2000	V
		Charged device model (CDM), per JEDEC specification JESD22-C101, all pins ⁽²⁾	±500	

- (1) JEDEC document JEP155 states that 500-V HBM allows safe manufacturing with a standard ESD control process.
(2) JEDEC document JEP157 states that 250-V CDM allows safe manufacturing with a standard ESD control process.

7.3 Recommended Operating Conditions

over operating free-air temperature range (unless otherwise noted)

		MIN	NOM	MAX	UNIT
V _{IN}	Input voltage	4		36	V
V _{OUT}	Output voltage (5 V)	0		5	V
	Output voltage (3.3 V)	0		3.3	V
	Output voltage (ADJ)	1.2		15	V
I _{OUT}	Output current (0.5 A)	0		0.5	A
T _J	Operating junction temperature	-40		125	°C

7.4 Thermal Information

THERMAL METRIC ⁽¹⁾		LMZM2360x	UNIT
		SIL (μSIP)	
		10 PINS	
R _{θJA}	Junction-to-ambient thermal resistance	45	°C/W
Ψ _{JT}	Junction-to-top characterization parameter	3	°C/W
Ψ _{JB}	Junction-to-board characterization parameter	20	°C/W

- (1) For more information about traditional and new thermal metrics, see the [Semiconductor and IC Package Thermal Metrics](#) application report.

7.5 Electrical Characteristics

Limits apply over the recommended operating junction temperature range of -40°C to $+125^{\circ}\text{C}$, unless otherwise stated. Minimum and maximum limits are ensured through test, design or statistical correlation. Typical values represent the most likely parametric norm at $T_J = 25^{\circ}\text{C}$, and are provided for reference purposes only. Unless otherwise stated, the following conditions apply: $V_{IN} = 24\text{ V}$.

PARAMETER		TEST CONDITIONS	MIN	TYP	MAX	UNIT
FEEDBACK						
V_{FB}	Initial output voltage accuracy (3.3-V and 5-V fixed output)	$V_{IN} = 4\text{ V to }36\text{ V}$, open loop	-1.5%		1.5%	
V_{FB}	Reference voltage (ADJ option)	$V_{IN} = 4\text{ V to }36\text{ V}$, open loop	0.985	1	1.015	V
I_{FB}	Input current from FB to GND (ADJ option)	FB = 1 V		20		nA
CURRENT						
I_Q	Operating quiescent current; measured at VIN pin	$V_{IN} = 12\text{ V}$, $V_{FB} = +10\%$, $V_{OUT} = 5\text{ V}$		7		μA
		$V_{IN} = 12\text{ V}$, $V_{FB} = +10\%$, $V_{OUT} = 5\text{ V}$, $T_J = 85^{\circ}\text{C}$			16	μA
		$V_{IN} = 12\text{ V}$, $V_{FB} = +10\%$, $V_{OUT} = 5\text{ V}$, $T_J = 125^{\circ}\text{C}$			18	
		$V_{IN} = 24\text{ V}$, $V_{FB} = +10\%$, $V_{OUT} = 5\text{ V}$		12		
		$V_{IN} = 24\text{ V}$, $V_{FB} = +10\%$, $V_{OUT} = 5\text{ V}$, $T_J = 85^{\circ}\text{C}$			24	
		$V_{IN} = 24\text{ V}$, $V_{FB} = +10\%$, $V_{OUT} = 5\text{ V}$, $T_J = 125^{\circ}\text{C}$			26	
I_B	Bias current into the VOUT pin	$V_{IN} = 24\text{ V}$, $V_{FB} = +10\%$, $V_{OUT} = 5\text{ V}$, Mode = 0 V		48	80	μA
I_{SD}	Shutdown quiescent current; measured at VIN pin	EN = 0 V, $V_{IN} = 12\text{ V}$, $T_J = 25^{\circ}\text{C}$		1.8		μA
		EN = 0 V, $V_{IN} = 12\text{ V}$, $T_J = 85^{\circ}\text{C}$			3	
		EN = 0 V, $V_{IN} = 24\text{ V}$, $T_J = 25^{\circ}\text{C}$		5		
		EN = 0 V, $V_{IN} = 24\text{ V}$, $T_J = 85^{\circ}\text{C}$			10	
UNDERVOLTAGE LOCKOUT (UVLO)						
V_{IN_UVLO}	Minimum input voltage to operate	Rising	3.1	3.5	3.85	V
$V_{IN_UVLO_HYST}$	UVLO hysteresis		0.2	0.25	0.3	V

Electrical Characteristics (continued)

Limits apply over the recommended operating junction temperature range of -40°C to $+125^{\circ}\text{C}$, unless otherwise stated. Minimum and maximum limits are ensured through test, design or statistical correlation. Typical values represent the most likely parametric norm at $T_J = 25^{\circ}\text{C}$, and are provided for reference purposes only. Unless otherwise stated, the following conditions apply: $V_{IN} = 24\text{ V}$.

PARAMETER	TEST CONDITIONS	MIN	TYP	MAX	UNIT		
POWER GOOD FLAG (PGOOD)							
V_{PGOOD_OV}	PGOOD upper threshold voltage	Rising, % of V_{out}		103.5%	106.7%	109%	
V_{PGOOD_UV}	PGOOD lower threshold voltage	Falling, % of V_{out}		92%	94.7%	97%	
V_{PGOOD_GUARD}	Magnitude of PGOOD lower threshold difference from steady state output voltage.	Steady state output voltage PGOOD threshold read at the same T_J and V_{IN}		4%			
V_{PGOOD_HYST}	PGOOD hysteresis as a percent of output voltage set point			1.4%			
V_{PGOOD_VALID}	Minimum input voltage for proper PGOOD function	50- μA pullup to PGOOD pin, $EN = 0\text{ V}$, $T_J = 25^{\circ}\text{C}$		1.0	1.5		V
t_{RESET_FILTER}	Glitch filter time constant for PGOOD function			190			μs
V_{OL}	Low-level PGOOD function output voltage	50- μA pullup to PGOOD pin, $V_{IN} = 1.5\text{ V}$, $EN = 0\text{ V}$			0.4		V
		0.5-mA pullup to PGOOD pin, $V_{IN} = 12\text{ V}$, $EN = 0\text{ V}$			0.4		
		1-mA pullup to PGOOD pin, $V_{IN} = 12\text{ V}$, $EN = 3.3\text{ V}$			0.4		
R_{PGOOD_RDSON}	RDSON of the PGOOD output pull down			50	110		Ω
SWITCHING FREQUENCY							
f_{SW}	Switching frequency	$V_{IN} = 24\text{ V}$, 5-V and 3.3-V fixed output options		675	750	825	kHz
		$V_{IN} = 24\text{ V}$, ADJ output options		890	1000	1090	
		$V_{IN} = 36\text{ V}$, 5-V and 3.3-V fixed output options		750			
		$V_{IN} = 36\text{ V}$, ADJ output options		800			
FREQUENCY SYNCHRONIZATION AND MODE							
f_{SYNC}	Sync frequency range	5-V and 3.3-V fixed output options $V_{OUT} + V_{DROPOUT} < V_{IN} < 36\text{ V}$		500		825	kHz
		ADJ output options $V_{OUT} + V_{DROPOUT} < V_{IN} < 28\text{ V}$		700		1100	
D_{SYNC}	Sync input duty cycle range	2.3 V < HIGH state input < 5.5 V		25%		75%	
V_{MODE_HIGH}	MODE/SYNC input logic HIGH voltage to enter FPWM mode			1.5			V
V_{MODE_LOW}	MODE/SYNC input logic LOW voltage to enter AUTO PFM mode					0.4	V
I_{MODE}	MODE/SYNC leakage current	$V_{IN} = 12\text{ V}$, $V_{MODE/SYNC} = 3.3\text{ V}$		1			μA
		$V_{IN} = 12\text{ V}$, $V_{MODE/SYNC} = 12\text{ V}$		5			
t_{MODE}	MODE transition time to FPWM	$V_{IN} = 12\text{ V}$, $V_{OUT} = 5\text{ V}$, $I_{OUT} = 20\text{ mA}$		300			μs
	MODE transition time to AUTO PFM	$V_{IN} = 12\text{ V}$, $V_{OUT} = 5\text{ V}$, $I_{OUT} = 20\text{ mA}$		300			
CURRENT LIMIT PROTECTION							
I_{L-HS}	0.5-A option high-side switch current limit	Duty cycle approaches 0%		0.94	1.35	1.6	A
I_{L-LS}	0.5-A option low-side switch current limit			0.5	0.625	0.75	A
I_{L-ZC}	Zero-cross current limit	MODE/SYNC = logic LOW		-0.01			A

Electrical Characteristics (continued)

Limits apply over the recommended operating junction temperature range of -40°C to $+125^{\circ}\text{C}$, unless otherwise stated. Minimum and maximum limits are ensured through test, design or statistical correlation. Typical values represent the most likely parametric norm at $T_J = 25^{\circ}\text{C}$, and are provided for reference purposes only. Unless otherwise stated, the following conditions apply: $V_{IN} = 24\text{ V}$.

PARAMETER		TEST CONDITIONS	MIN	TYP	MAX	UNIT
I_{L-NEG}	Low-side reverse current limit (positive current into the SW pin to GND)	MODE/SYNC = logic HIGH	0.5	0.8		A
POWER STAGE CHARACTERISTICS						
HS R_{DS-ON}	High-side MOSFET on-resistance			220		$\text{m}\Omega$
LS R_{DS-ON}	Low-side MOSFET on-resistance			200		$\text{m}\Omega$
t_{ON-MIN}	Minimum high-side on-time	$I_{OUT} = 500\text{ mA}$		50	80	ns
$t_{OFF-MIN}$	Minimum high-side off-time	$I_{OUT} = 500\text{ mA}$, ADJ		62	100	ns
D_{MAX}	Maximum switch duty cycle	5-V and 3.3-V fixed output options		93%		
		ADJ option		91%		
		While in frequency foldback		97%		
L	Integrated inductor - inductance			10		μH
L_{DCR}	Integrated inductor - DCR			390		$\text{m}\Omega$
ENABLE						
V_{EN}	Enable input threshold voltage	Rising	1.7		1.92	V
V_{EN_HYST}	Enable input threshold hysteresis		0.42		0.52	V
V_{EN_WAKE}	Enable input wake-up threshold		0.4			V
I_{EN}	Enable pin input current	$V_{IN} = V_{EN} = 12\text{ V}$		2.7		μA
VCC REGULATOR						
V_{CC}	Internal V_{CC} voltage	$V_{IN} = 12\text{ V}$, $V_{OUT} < 3.3\text{ V}$		3.05		V
		$V_{IN} = 12\text{ V}$, $V_{OUT} \geq 3.3\text{ V}$		3.15		
V_{CC_UVLO}	Internal V_{CC} voltage input UVLO	V_{IN} rising	2.23	2.73	3.25	V
$V_{CC_UVLO_HYST}$	Internal V_{CC} voltage input UVLO hysteresis	Hysteresis below V_{CC_UVLO}	150		240	mV
SOFT START						
t_{SS}	Soft-start time	Time for V_{REF} to ramp from 0% to 90%	1.8	3.5	5.5	ms
t_{EN_LV}	Turnon delay with low V_{IN}	$V_{IN} < 4.2\text{ V}$		4		ms
t_{EN}	Turnon delay	$V_{IN} = 12\text{ V}$		0.7		ms
t_W	Short circuit wait time (hiccup time)			8.0		ms
THERMAL PROTECTION						
T_{SD}	Thermal shutdown	Rising threshold		155		$^{\circ}\text{C}$
T_{SD_HYST}	Thermal shutdown hysteresis			15		$^{\circ}\text{C}$

7.6 System Characteristics

The following specifications apply to a typical applications circuit, with nominal component values. Specifications in the typical (TYP) column apply to $T_J = 25^\circ\text{C}$. Specifications in the minimum (MIN) and maximum (MAX) columns apply to the case of typical components over the temperature range of $T_J = -40^\circ\text{C}$ to 125°C . These specifications are not ensured by production testing.

PARAMETER		TEST CONDITIONS	MIN	TYP	MAX	UNIT
SUPPLY CURRENT						
I_{Q-VIN}	Input current to the DC-DC converter while in regulation	$V_{IN} = 12\text{ V}$, $V_{OUT} = 3.3\text{ V}$, $I_{OUT} = 0\text{ A}$, fixed output option, EN connected to V_{IN}		25		μA
		$V_{IN} = 12\text{ V}$, $V_{OUT} = 5\text{ V}$, $I_{OUT} = 0\text{ A}$, fixed output option, EN connected to V_{IN}		32		
		$V_{IN} = 24\text{ V}$, $V_{OUT} = 3.3\text{ V}$, $I_{OUT} = 0\text{ A}$, fixed output option, EN connected to V_{IN}		24		
		$V_{IN} = 24\text{ V}$, $V_{OUT} = 5\text{ V}$, $I_{OUT} = 0\text{ A}$, fixed output option, EN connected to V_{IN}		28		
EFFICIENCY						
Efficiency	Typical efficiency 12-V input	$V_{IN} = 12\text{ V}$, $V_{OUT} = 5\text{ V}$, $I_{OUT} = 0.5\text{ A}$		90%		
Efficiency	Typical efficiency 12-V input	$V_{IN} = 12\text{ V}$, $V_{OUT} = 3.3\text{ V}$, $I_{OUT} = 0.5\text{ A}$		87%		
Efficiency	Typical efficiency 24-V input	$V_{IN} = 24\text{ V}$, $V_{OUT} = 5\text{ V}$, $I_{OUT} = 0.5\text{ A}$		87%		
Efficiency	Typical efficiency 24-V input	$V_{IN} = 24\text{ V}$, $V_{OUT} = 3.3\text{ V}$, $I_{OUT} = 0.5\text{ A}$		83%		
Efficiency	Typical efficiency 24-V input	$V_{IN} = 24\text{ V}$, $V_{OUT} = 12\text{ V}$, $I_{OUT} = 0.5\text{ A}$		93%		

7.7 Typical Characteristics

$V_{IN} = 24\text{ V}$, $T_A = 25^\circ\text{C}$ (unless otherwise noted). Refer to default evaluation board layout and bill of materials.



图 1. Maximum Input Voltage for $V_{OUT} < 2.5\text{V}$



Fixed output voltage options
Output voltage in regulation

D041
EN = VIN
Load = Open

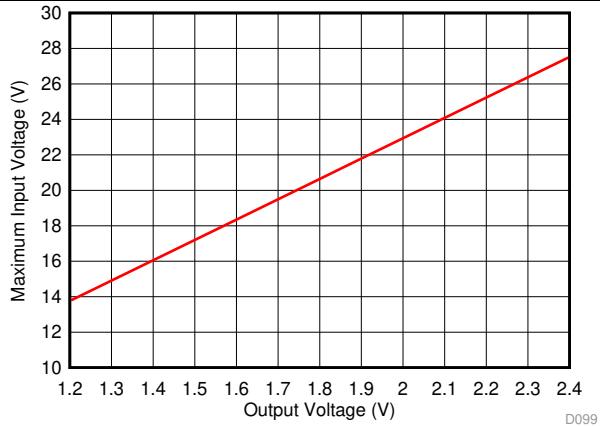
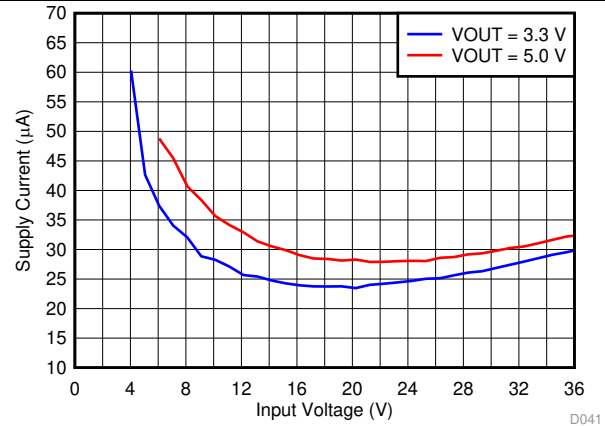
图 2. Input Supply Current

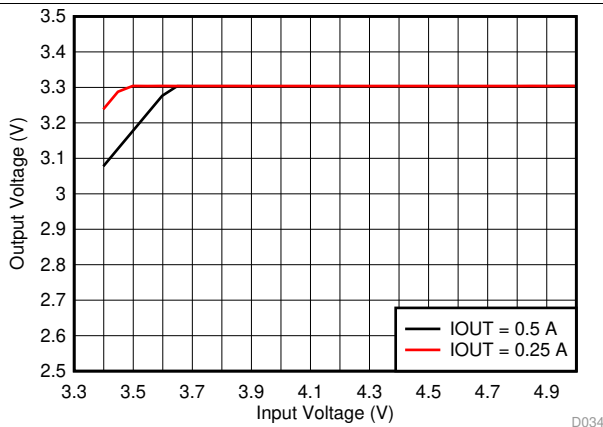

$V_{OUT} = 3.3\text{ V}$

图 3. Dropout Voltage

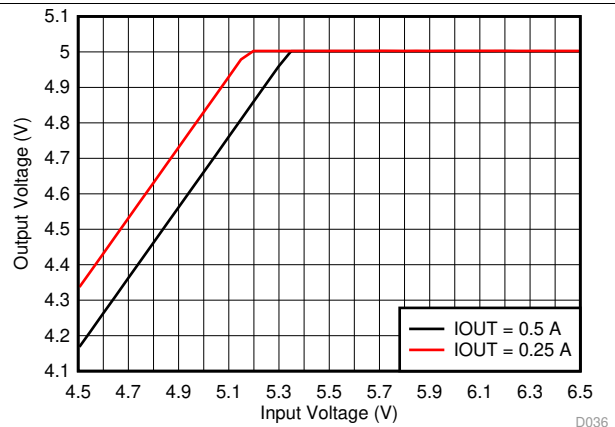

$V_{OUT} = 5\text{ V}$

图 4. Dropout Voltage

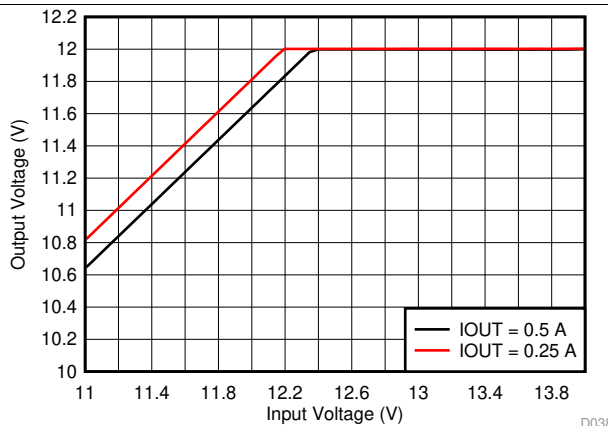

$V_{OUT} = 12\text{ V}$

图 5. Dropout Voltage

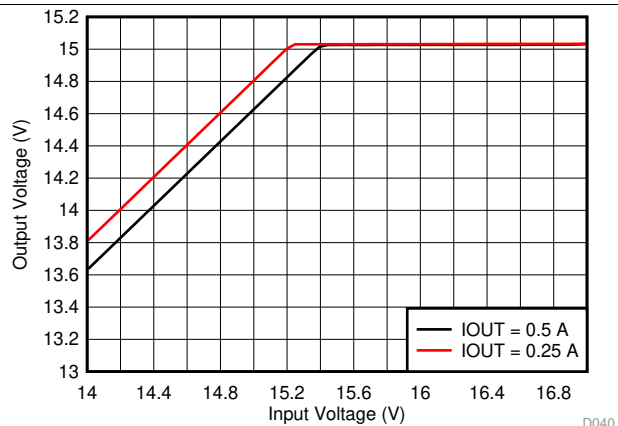

$V_{OUT} = 15\text{ V}$

图 6. Dropout Voltage

Typical Characteristics (接下页)

$V_{IN} = 24\text{ V}$, $T_A = 25^\circ\text{C}$ (unless otherwise noted). Refer to default evaluation board layout and bill of materials.



图 7. Radiated EMI



图 8. Package Thermal Resistance vs Board Copper Area, No Air Flow

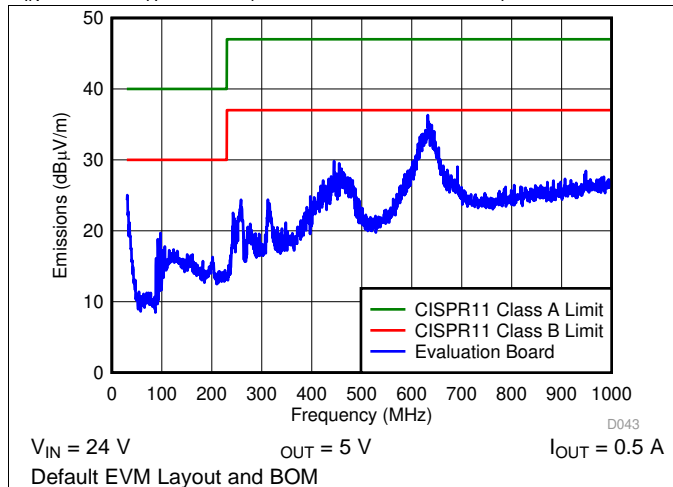

图 9. Power Dissipation

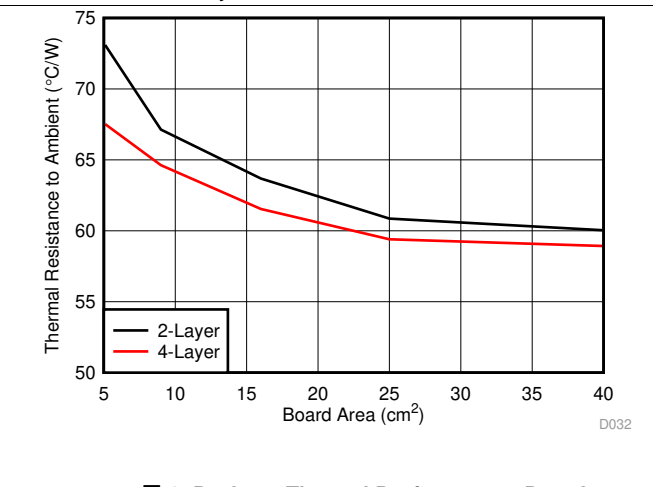

图 10. Power Dissipation

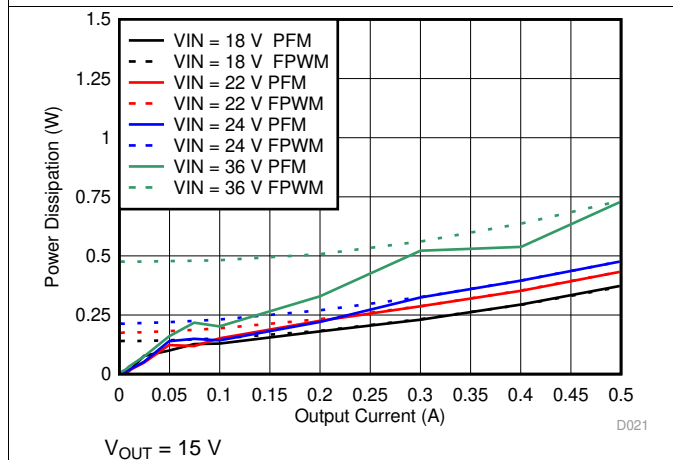

图 11. Power Dissipation

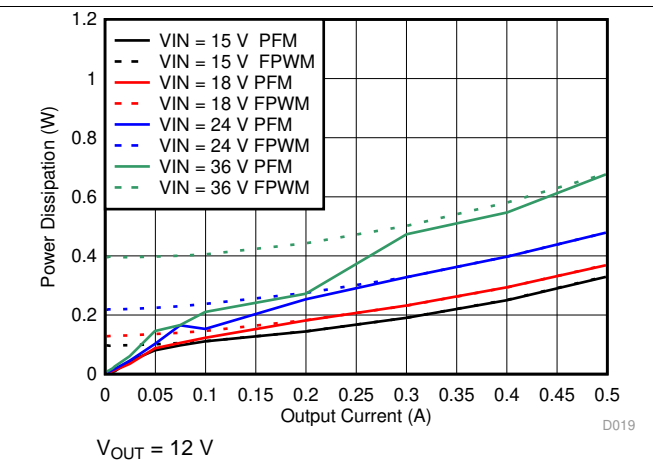

图 12. Power Dissipation

Typical Characteristics (接下页)

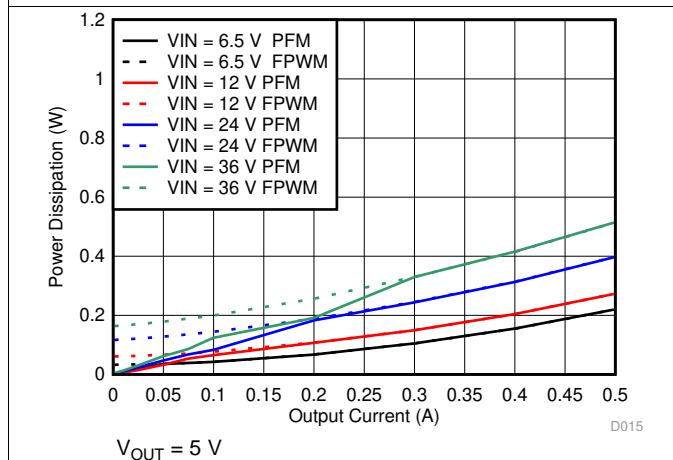
$V_{IN} = 24\text{ V}$, $T_A = 25^\circ\text{C}$ (unless otherwise noted). Refer to default evaluation board layout and bill of materials.

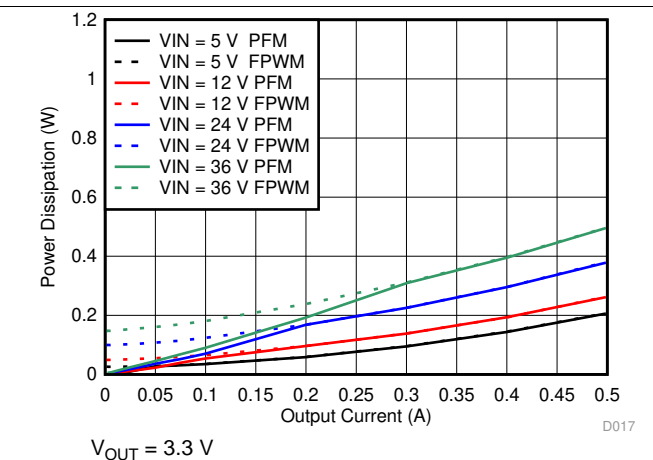
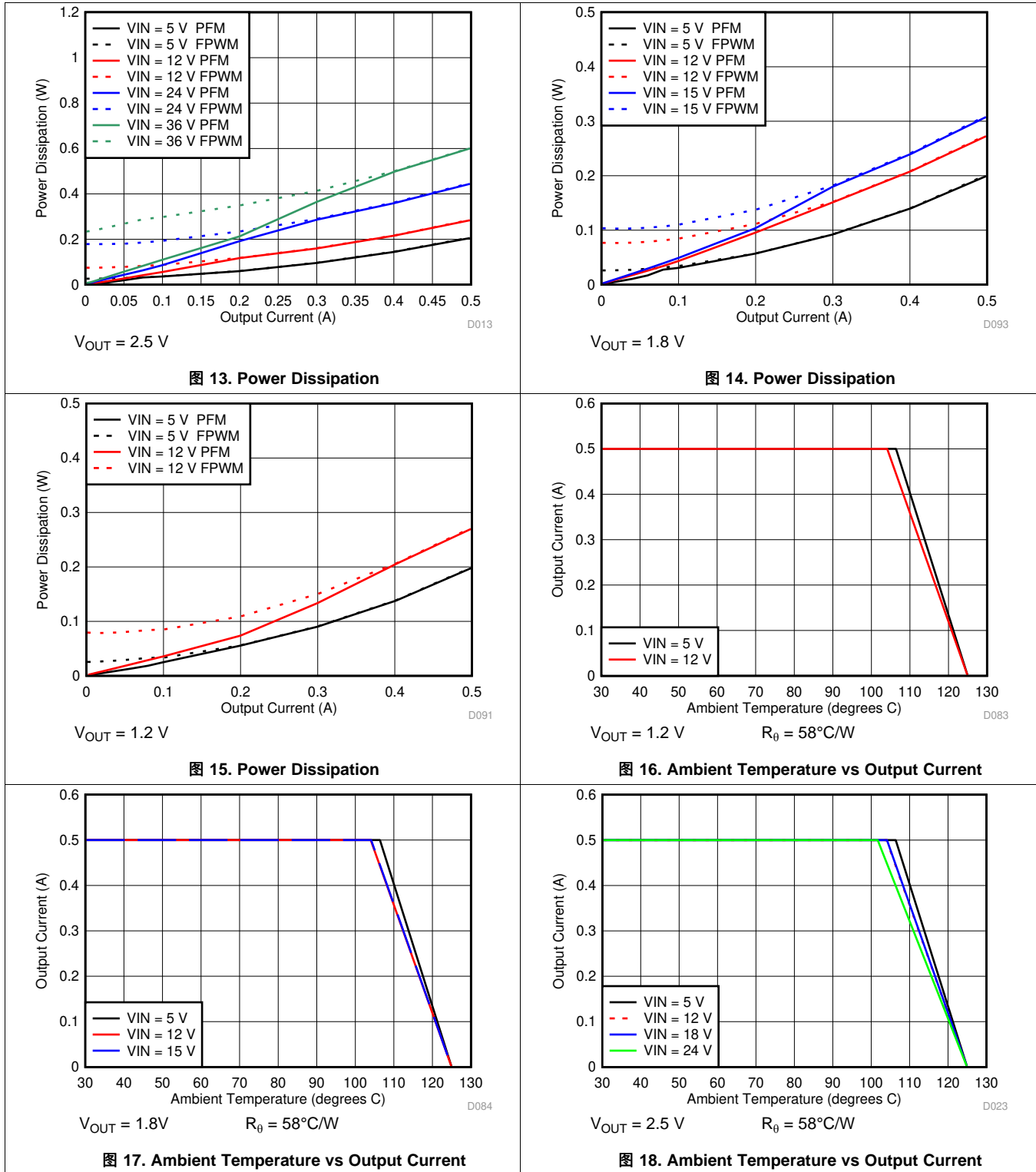

Typical Characteristics (接下页)

$V_{IN} = 24\text{ V}$, $T_A = 25^\circ\text{C}$ (unless otherwise noted). Refer to default evaluation board layout and bill of materials.



图 19. Ambient Temperature vs Output Current



图 20. Ambient Temperature vs Output Current

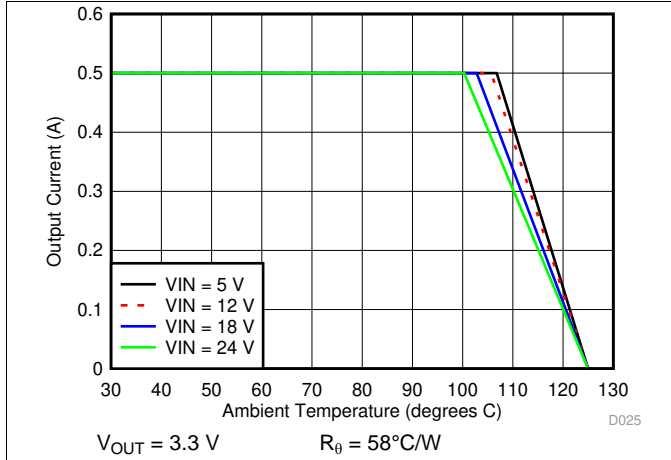

图 21. Ambient Temperature vs Output Current

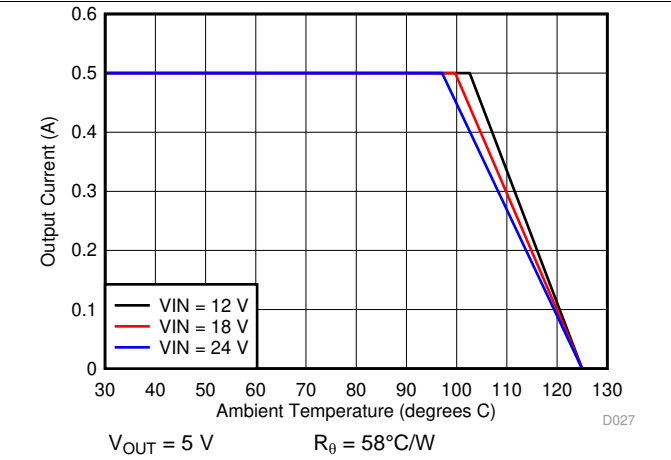

图 22. Ambient Temperature vs Output Current

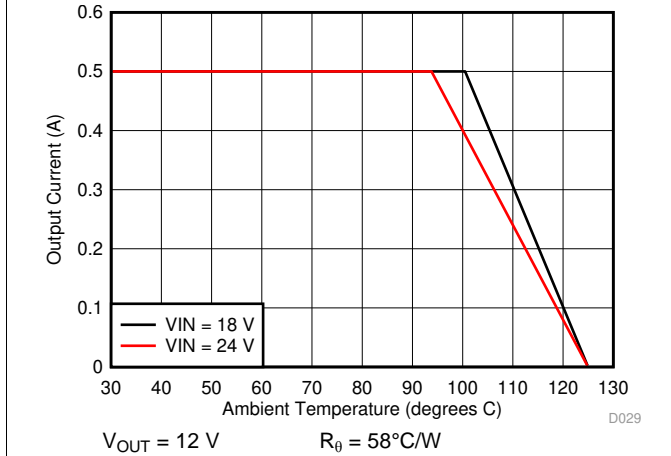

图 23. Auto PFM Mode Switching Frequency vs Output Current

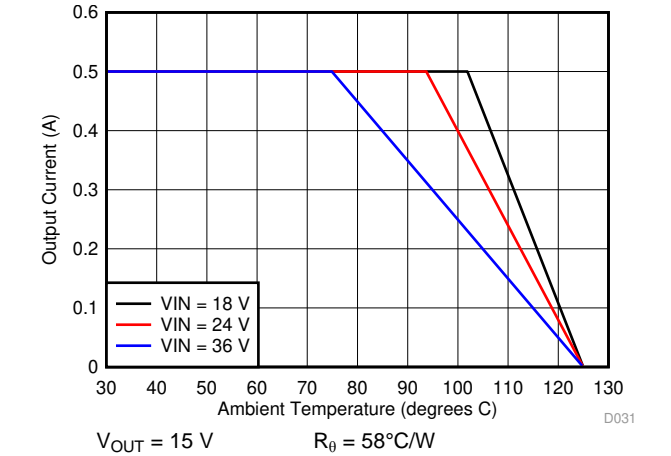

图 24. Auto PFM Mode Switching Frequency vs Output Current

Typical Characteristics (接下页)

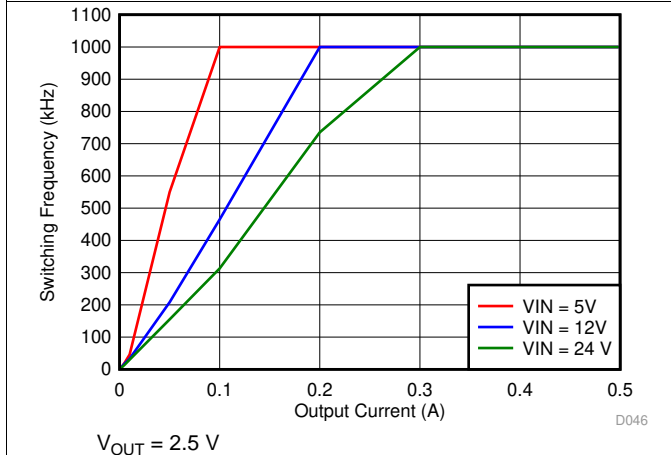
$V_{IN} = 24\text{ V}$, $T_A = 25^\circ\text{C}$ (unless otherwise noted). Refer to default evaluation board layout and bill of materials.

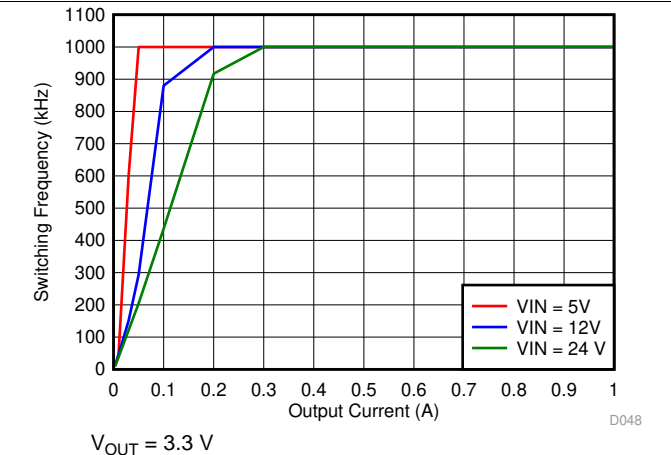
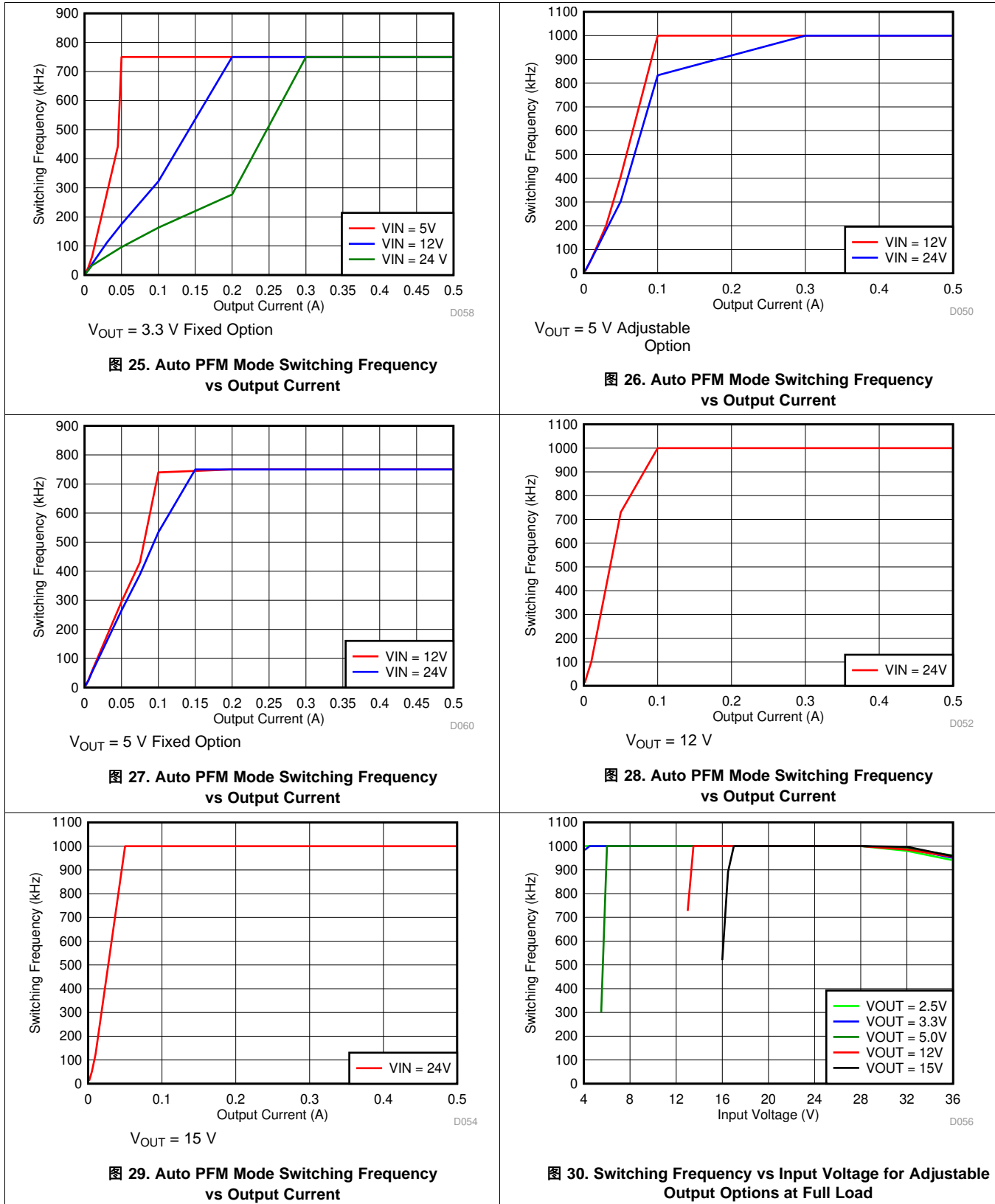

Typical Characteristics (接下页)

$V_{IN} = 24\text{ V}$, $T_A = 25^\circ\text{C}$ (unless otherwise noted). Refer to default evaluation board layout and bill of materials.



图 31. Switching Frequency vs Input Voltage for Fixed Output Options at Full Load

8 Detailed Description

8.1 Overview

The LMZM23600 is a 4-V to 36-V wide-input voltage range, low quiescent current, high-performance DC/DC module designed specifically for space-constrained industrial applications. The device is available in an adjustable output voltage option with 1.2-V to 15-V output range, as well as fixed 5-V and 3.3-V output options. The high level of integration and innovative packaging technology utilized in this power module makes it possible to design a 5-V or a 3.3-V 0.5-A DC/DC converter with only an input capacitor and an output capacitor in just 27 mm² of available board space.

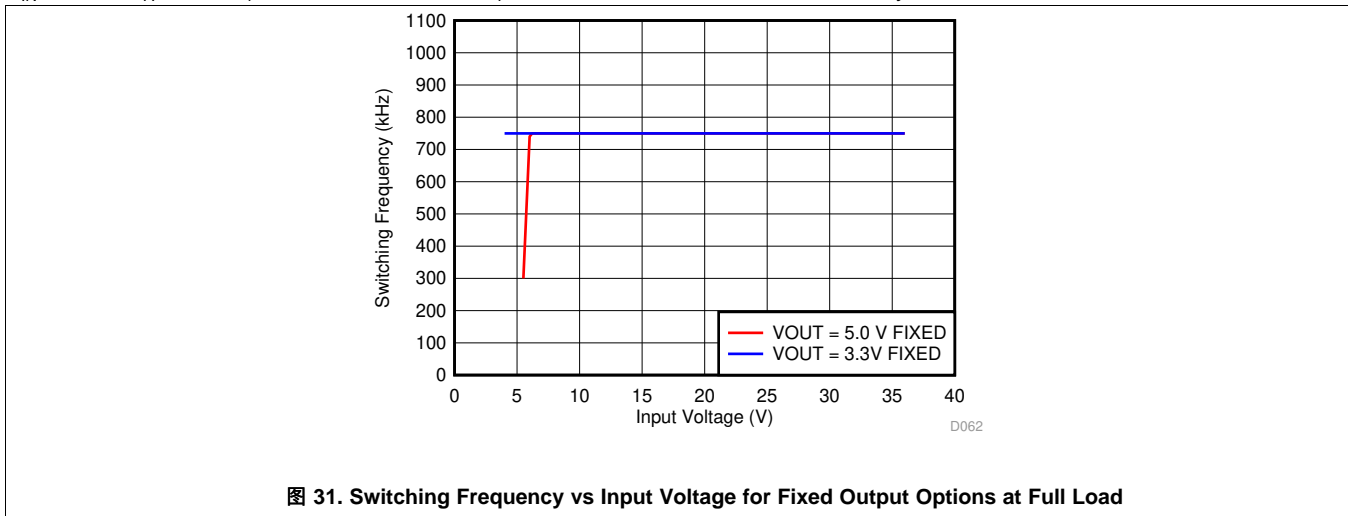
8.2 Functional Block Diagram

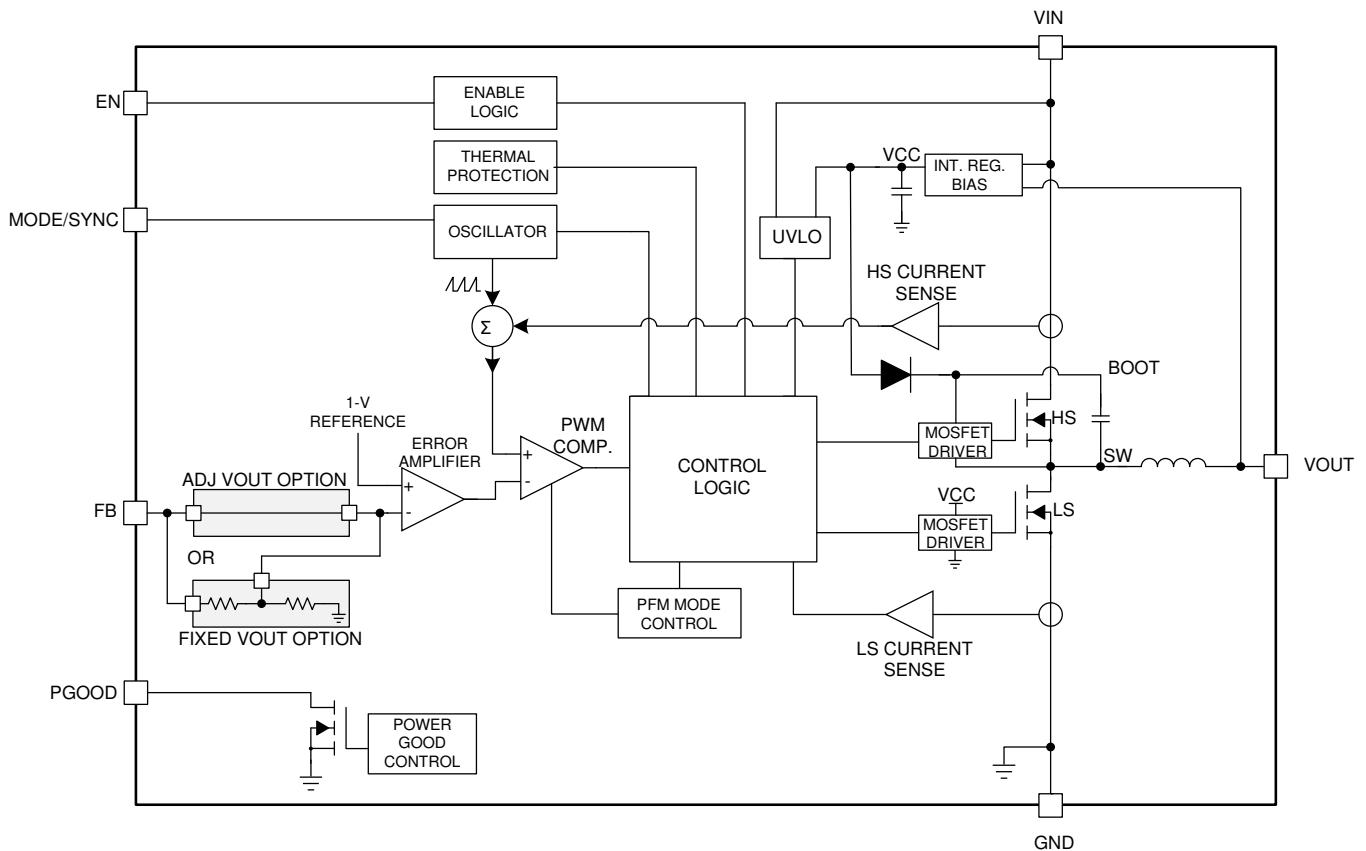

8.3 Feature Description

8.3.1 Control Scheme

The LMZM23600 power module utilizes peak-current-mode-control architecture. This enables the use of wide range of input voltages while maintaining constant switching frequency and good input and output transient response. The device can be used with 5-V, 12-V, or 24-V typical industrial input voltage rail. The short minimum on- and off-times ensure constant frequency regulation over a wide range of input to output voltage conversion ratios. The adjustable (ADJ) output voltage option operates at 1000-kHz switching frequency. The minimum on- and off- times allow for a duty factor window of 5% to 91% at 1000-kHz switching frequency. If the input voltage exceeds approximately 28 V on the ADJ version, the frequency is smoothly reduced from 1000 kHz as a function of input voltage. The switching frequency reduction allows output voltage regulation and the current mode control to operate with a duty factor below 5%. The fixed 5-V and 3.3-V output options operate at 750 kHz nominal switching frequency and the frequency foldback at high input voltage is not active or needed.

Feature Description (接下页)

The control architecture also uses frequency foldback at low input voltage in order to achieve low dropout voltage, maintaining output regulation as the input voltage falls close to output voltage. The frequency foldback at low input voltage is active for the ADJ as well as the 5-V and 3.3-V output options. The reduction in frequency is smooth and continuous and is activated as the off-time approaches the minimum value. Under these conditions, the LMZM23600 device operates much like a constant off-time converter allowing the maximum duty cycle to reach 97%. This feature allows output voltage regulation with very low dropout.

The LMZM23600 features exceptional conversion efficiency at light load. As the load current is reduced, the LMZM23600 transitions to light-load mode if the MODE/SYNC terminal is pulled low. In light-load mode the device uses diode emulation to reduce the RMS inductor current and the switching frequency is reduced. The fixed voltage versions (3.3-V and 5-V) do not need an external voltage divider connected to FB, which results in saving two components and lower standby current when the load is in standby. As a result, the consumed supply current is only 24 μ A (typical) with 24-V to 3.3-V conversion and 28 μ A (typical) with 24-V to 5-V conversion, while the output is regulated with no load.

8.3.2 Soft-Start Function

The LMZM23600 features an internally programmed soft-start time. The soft-start time is fixed internally at about 4 ms and is achieved by ramping the internal reference. The device starts up properly even if there is a voltage present on output before the activation of the LMZM23600. In such cases, there is no switching until the output voltage value programmed by the ramping reference voltage is above the pre-biased output value. Once the prebiased voltage level is reached by the reference ramp, the switching starts, and the output ramps up smoothly from the pre-biased value up to the final output voltage.

8.3.3 Enable and External UVLO Function

Some applications may require a precision enable or custom input voltage lockout (UVLO) functionality. Setting up external UVLO based on the application needs would prevent the converter from trying to regulate the output voltage until after the input voltage has reached a desired minimum level. Such function can be used to lower the current demand from the input supply as the supply is still starting up.

The LMZM23600 features a precision enable (EN) input terminal. The EN input logic has two internal thresholds. The first rising threshold is at 0.9V typical. Its purpose is to wake up the internal VCC regulator to bias the internal circuitry. The EN rising threshold to start switching is 1.8V (typical) with 0.5V (typical) hysteresis. A voltage divider from VIN to EN can be used to set the VIN voltage at which the regulator starts the voltage conversion. The EN terminal is rated for up to the input voltage and can be connected directly to VIN for an always-on operation. Pulling the EN pin below 0.4 V puts the LMZM23600 in shutdown mode. In shutdown mode and 12-V input voltage the LMZM23600 only consumes 1.8 μ A (typical) of input current.

8.3.4 Current Limit

The LMZM23600 devices features two current limits inside the IC. A coarse high side or peak current limit is provided to protect against faults. The high-side current limit limits the duration of the on-period of the high-side power MOSFET during a given clock cycle. A precision cycle-by-cycle valley current limit prevents excessive average output current. A new switching cycle is not initiated until the inductor current drops below the valley current limit.

Feature Description (接下页)



图 32. Current Limit Operation During Output Short Circuit

图 32 shows the response of the LMZM23600 device to a short circuit on the output: The peak current limit prevents excessive peak current while the valley current limit prevents excessive average inductor current. After a small number of cycles, hiccup mode is activated.

8.3.5 Hiccup Mode

In order to prevent excessive heating and power consumption under sustained output short-circuit conditions, a hiccup mode operation is included in the control logic. If an over current condition is maintained on the output, the LMZM23600 device shuts off both power MOSFETs and waits for a hiccup interval, t_w , of approximately 8 ms. After the wait period, the device restarts operation beginning with a soft-start time interval.

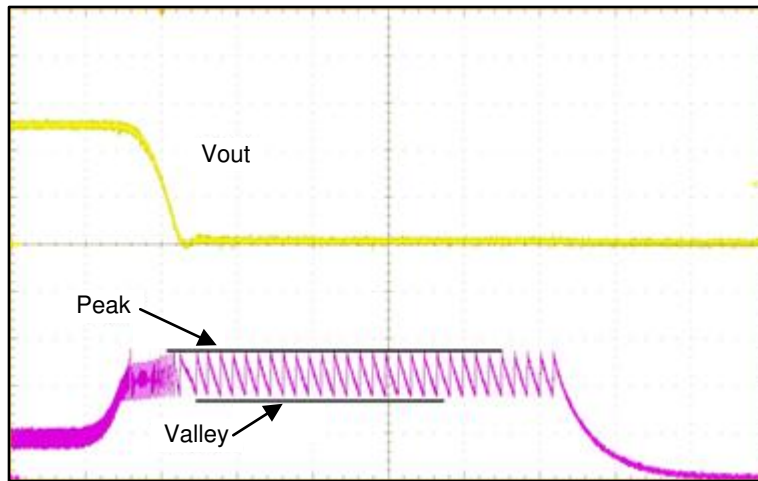

图 33. Hiccup Operation

图 33 shows hiccup mode operation: The LMZM23600 attempts to restart periodically, following a hiccup wait interval. If the fault at the output is still present, another hiccup wait interval is initiated, followed by another restart attempt. This sequence continues until the output short circuit is removed. When the output short circuit is removed, the output ramps up during the next restart sequence.

Feature Description (接下页)

8.3.6 Power Good (PGOOD) Function

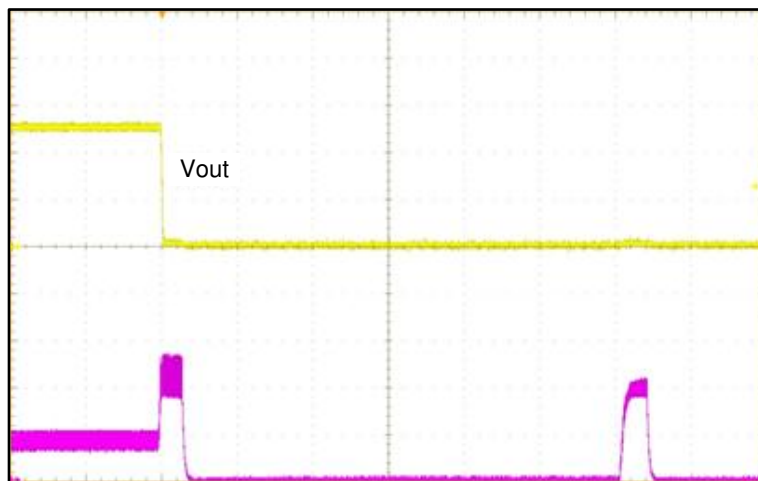
The LMZM23600 has a built-in power-good signal presented at the PGOOD terminal. This signal indicates whether the output voltage is within the regulation window. The PGOOD terminal is an open-drain output that requires a pullup resistor to a nominal voltage source of 15 V or less. The absolute maximum PGOOD sink current is 8 mA. Typically, TI recommends a pullup resistor value between 10 k Ω and 100 k Ω . Refer to [Electrical Characteristics](#) for the power-good thresholds and hysteresis for undervoltage and overvoltage detection.

8.3.7 MODE/SYNC Function

8.3.7.1 Forced PWM Mode

When constant frequency operation is more important than light load efficiency, the MODE/SYNC input of the LMZM23600 device must be pulled high or a valid synchronization input must be provided. This activates forced-PWM-mode operation. Once activated, this feature ensures that the switching frequency stays constant across the entire load current range, while operating between the minimum and maximum duty cycle limits. The diode emulation feature is turned off in this mode. This means that the device remains in CCM under light loads. The switching frequency in forced PWM mode is only reduced when the input voltage-to-output voltage ratio results in minimum on-time limitation (ADJ version only) or minimum off-time limitation near dropout.

This feature may be activated and deactivated while the part is regulating without removing the load. This feature activates and deactivates gradually, preventing perturbation of output voltage. When in FPWM mode, a limited reverse current is allowed through the inductor allowing power to pass from the regulators output to its input.

8.3.7.2 Auto PFM Mode

If the MODE/SYNC terminal is held low the LMZM23600 device enables automatic power-saving-mode transition at light load. With high load the LMZM23600 regulates the output using normal PWM operation. When the load is light, the control logic smoothly transitions to PFM operation and diode emulation. In this mode, the high side MOSFET is turned on for one or more pulses to provide energy to the load. The on-time of the high side in this mode depends on the input voltage level and a pre-programmed internal $I_{PEAK-MIN}$ current level. The higher the input voltage is, the shorter the on-time is. At this point, there is a longer off-time during which the output would still be in the regulation window because the load is light, and the output is not getting discharged as quickly. The duration of the off-time depends on the load current level. Lighter load results in longer off-time. This mode of operation results in excellent conversion efficiency at very light load. When auto-PFM mode is used, the output voltage at no load is approximately 1% higher than FPWM operation.

8.3.7.3 Dropout Mode

When the input voltage level decreases and approaches the output voltage level, the buck regulator reaches its maximum duty cycle or minimum off-time requirement for each switching cycle. At this point the output is no longer regulated and follows the input voltage minus the voltage drops from V_{IN} to V_{OUT} .

In order to maximize the input voltage range for which the output is still regulated, the LMZM23600 features frequency foldback at low input voltage. This operation extends the switching period and, for a given fixed minimum off-time, it prolongs the maximum duty cycle of the regulator. As a result, the output voltage can still be well regulated even as the input voltage level is very close to the output voltage. This feature can be useful for battery applications (maximizing the useful battery range) or in applications where large input voltage variations can be expected.

Feature Description (接下页)

8.3.7.4 SYNC Operation

It is often desirable to synchronize the switching frequency of multiple regulators in a single system. This technique results in better defined EMI behavior and can reduce the need for capacitance on some power rails. The LMZM23600 MODE/SYNC input allows synchronization to an external clock. The LMZM23600 implements an in-phase locking scheme – the rising edge of the clock signal provided to the input of the LMZM23600 device corresponds to turning on the high-side MOSFET device. This function is implemented using phase locking over a limited frequency range eliminating large glitches upon initial application of an external clock. The clock fed into the LMZM23600 device replaces the internal free-running clock but does not affect frequency foldback operation. The foldback function takes over and the output voltage continues to be well regulated using frequency reduction when duty factors outside of the normal duty cycle range are reached. When the device is synchronized to the lower end of the synchronization range the internal inductor will see higher peak currents. For high current ripple designs (for example, high input voltage and 12-V and 15-V output designs), the maximum current capability of the device may be derated.

The device remains in FPWM mode and operates in CCM for light loads when synchronization input is provided.

The MODE/SYNC function logic always prioritizes the proper regulation of the output voltage. 表 2 summarizes the MODE/SYNC function and the operating switching frequency with various conditions. See [Typical Characteristics](#) for frequency foldback vs input voltage behavior.

表 2. Switching Frequency and MODE/SYNC Function

DEVICE	SWITCHING FREQUENCY				
	MODE/SYNC	LIGHT LOAD	FULL LOAD	VIN > 28 V	IN DROPOUT MODE
ADJ Output	Logic LOW = Auto PFM	Reduced (save power)	Fixed 1000 kHz	Reduced (maintain regulation)	Reduced (maintain regulation)
	Logic HIGH = FPWM	Fixed 1000 kHz	Fixed 1000 kHz	Reduced (maintain regulation)	Reduced (maintain regulation)
	Valid F _{SYNC} Input	F _{SYNC}	F _{SYNC}	Reduced (maintain regulation)	Reduced (maintain regulation)
Fixed 3.3-V Output or 5-V Output	Logic LOW = Auto PFM	Reduced (save power)	Fixed 750 kHz	Fixed 750 kHz	Reduced (maintain regulation)
	Logic HIGH = FPWM	Fixed 750 kHz	Fixed 750 kHz	Fixed 750 kHz	Reduced (maintain regulation)
	Valid F _{SYNC} Input	F _{SYNC}	F _{SYNC}	F _{SYNC}	Reduced (maintain regulation)

8.3.8 Thermal Protection

The LMZM23600 monitors its junction temperature (T_J) and shuts off if the it gets too hot. The thermal shutdown threshold for the junction is typically 155°C. Both, high-side and low-side power MOSFETs are turned off until the junction temperature has decreased under the hysteresis level, typically 15°C below the shutdown temperature.

8.4 Device Functional Modes

8.4.1 Shutdown

The LMZM23600 device shuts down most internal circuitry and high-side and low-side power MOSFETs under any of the following conditions:

1. EN is low
2. VIN is below the falling UVLO threshold
3. Junction temperature exceeds T_{SD} threshold

The PGOOD flag remains operational with input voltage as low as 1.5 V.

8.4.2 FPWM Operation

If MODE/SYNC is above the $V_{MODE/SYNC}$ high threshold or a valid synchronizing is applied to MODE/SYNC, constant frequency operation is maintained across load. The ADJ option of the device folds back the frequency when V_{IN} exceeds 28 V typical so that the output voltage can be properly regulated. See [表 2](#) for all use cases and options. FPWM mode requires negative current be allowed in the inductor if the load is light. If a large negative load is present, operation is halted by a reverse current limit, I_{L-NEG} .

8.4.3 Auto PFM Mode Operation

If MODE/SYNC is below the $V_{MODE/SYNC}$ low threshold, reverse current in the inductor is not allowed. This feature is called diode emulation. While the load is heavy, the regulator uses PWM mode to control the output. If the load is light, the control logic transitions to PFM mode. The switching frequency is reduced, resulting in excellent energy savings while regulation is maintained. Because the frequency is reduced and switching pulses can come in groups, the output voltage ripple can increase slightly. Under this condition, the output ripple can be reduced by increasing the output capacitance.

9 Application and Implementation

注

Information in the following applications sections is not part of the TI component specification, and TI does not warrant its accuracy or completeness. TI's customers are responsible for determining suitability of components for their purposes. Customers should validate and test their design implementation to confirm system functionality.

9.1 Application Information

The LMZM23600 device is a step-down power module, typically used to efficiently convert a high DC input voltage to a lower DC output voltage with a maximum output current of up to 1 A. The following sections describe a simple design procedure for creating a DC/DC converter design with these modules.

9.2 Typical Applications

The LMZM23600 module requires very few external components for a complete DC/DC converter design. If the output voltage for the application is 3.3 V or 5 V, the fixed output voltage option of the LMZM23600 device can be used. In such cases, the design is as simple as adding only an input and an output capacitor. The adjustable output voltage version of the device allows the user to set the output voltage between 1.2 V and 15 V with the addition of two feedback resistors to the bill of materials.

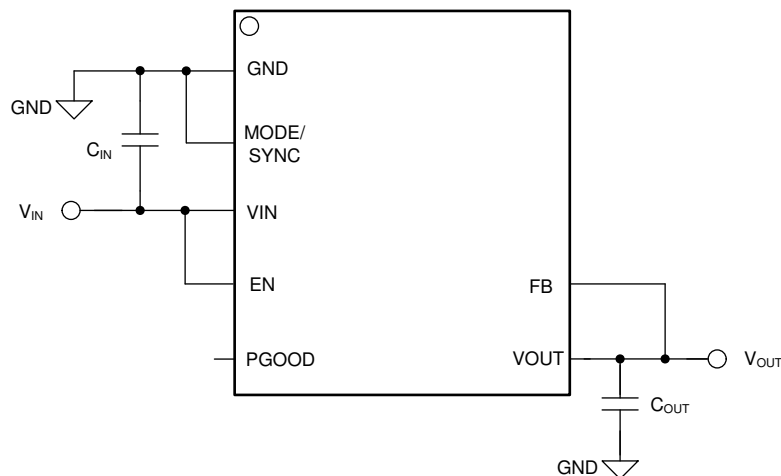

Copyright © 2017, Texas Instruments Incorporated

图 34. Fixed 5-V or 3.3-V Typical Application Circuit

Typical Applications (接下页)

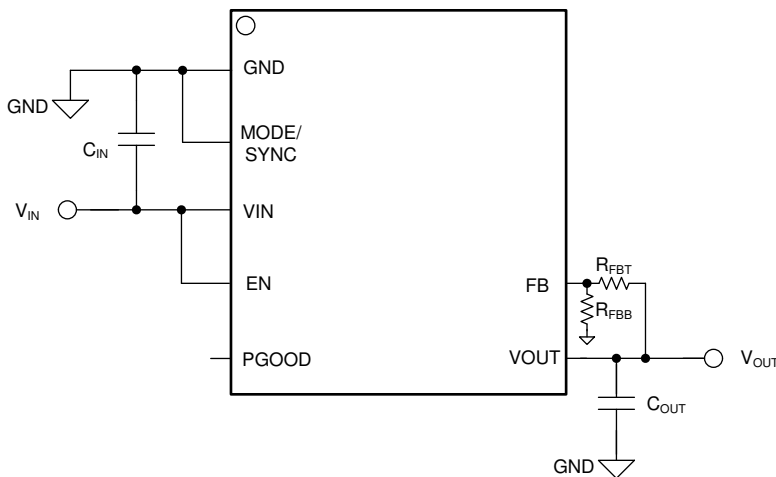

Copyright © 2017, Texas Instruments Incorporated

图 35. Adjustable 1.2-V to 15-V Output Typical Application Circuit

9.2.1 Design Requirements

9.2.1.1 Maximum Input Voltage for $V_{OUT} < 2.5\text{ V}$

For designs requiring V_{OUT} less than 2.5 V the maximum input voltage is limited by the switching frequency and the minimum on-time. See 图 36.



图 36. Maximum Input Voltage for $V_{OUT} < 2.5\text{V}$

For this design example, use the parameters listed in 表 3 as the input parameters.

表 3. Design Parameters

DESIGN PARAMETER	VALUE	COMMENT
Input voltage range	8 V to 36 V	This range covers a typical 12-V or 24-V industrial supply
Output voltage	5 V	Fixed or adjustable output voltage can be used
Output current range	No load to 0.5 A	

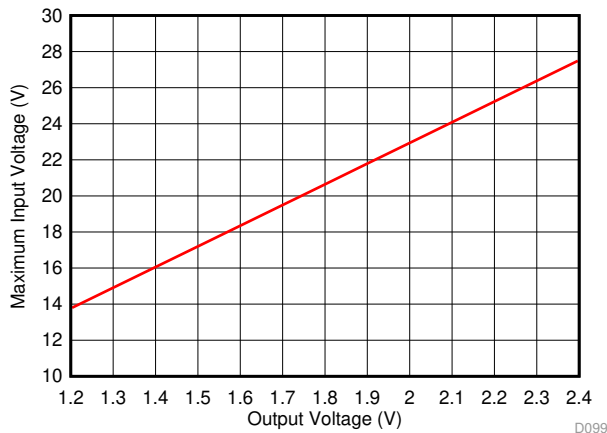
9.2.2 Detailed Design Procedure

9.2.2.1 Custom Design With WEBENCH® Tools

[Click here](#) to create a custom design using the LMZM23600 device with the WEBENCH® Power Designer.

1. Start by entering the input voltage (V_{IN}), output voltage (V_{OUT}), and output current (I_{OUT}) requirements.
2. Optimize the design for key parameters such as efficiency, footprint, and cost using the optimizer dial.
3. Compare the generated design with other possible solutions from Texas Instruments.

The WEBENCH Power Designer provides a customized schematic along with a list of materials with real-time pricing and component availability.

In most cases, these actions are available:

- Run electrical simulations to see important waveforms and circuit performance
- Run thermal simulations to understand board thermal performance
- Export customized schematic and layout into popular CAD formats
- Print PDF reports for the design, and share the design with colleagues

Get more information about WEBENCH tools at www.ti.com/WEBENCH.

9.2.2.2 Input Capacitor Selection

The input capacitor selection and placement on the board layout is very important for any buck converter design. This component provides the pulsing high di/dt current every switching cycle and reduces the input voltage ripple seen by the buck converter. Use a good-quality 10- μ F, 1210 (3225) case size, X5R or X7R ceramic capacitor with sufficient voltage rating on the input of the device. Alternatively, in applications with strict size constraints and more stable input voltage it is possible to use a 10- μ F, 1206 (3216) case size or a parallel combination of 2 \times 4.7- μ F, 0805 (2012), X5R or X7R capacitors. Ceramic capacitors have a DC bias dependence on their effective capacitance and can de-rate their value significantly when used at higher bias voltage. TI recommends ceramic capacitors with \geq 50-V rating when using the device with a 24-V input supply. Ceramic capacitors with \geq 25-V rating are recommended when using the device with a 12-V input supply.

Just like with any buck converter, place the input capacitor as close as possible and next to the LMZM23600. Connect the capacitor directly to the VIN (pin 3) and GND (pin 1) terminals of the device. This placement ensures that the area of the high di/dt current loop in the buck converter is kept to a minimum, resulting in the lowest possible inductance in the switching current path. The proper placement of the **input capacitor** in any buck converter helps to keep the **output noise** of the converter to a minimum. See [表 4](#) for several input capacitor choices.

表 4. Input Capacitor Selection

VALUE	VOLTAGE RATING	CASE SIZE	DIELECTRIC	QUANTITY	VENDOR	PART NUMBER
10 μ F	50 V	1210 (3225)	X7R	1	TDK	C3225X7R1H106M250AC
10 μ F	50 V	1210 (3225)	X7R	1	MuRata	GRJ32ER71H106KE11
10 μ F	50 V	1206 (3216)	X5R	1	TDK	C3216X5R1H106K160AB
4.7 μ F	50 V	0805 (2012)	X5R	2	TDK	C2012X5R1H475K125AB

For this design example a single 10- μ F, 50-V 1210 X7R capacitor is used.

9.2.2.3 Output Capacitor Selection

TI recommends low-ESR ceramic capacitors for output capacitors. There is a requirement for minimum capacitance on the output of the LMZM23600 in order to ensure stable operation. The minimum output capacitance requirement depends on the output voltage setting. There is also a maximum capacitance value for stability and in order to limit the in-rush supply current. Excessive output capacitance can result in excessive current to be drawn from the input supply during startup. If the overcurrent condition is persistent during start-up, the over current protection of the LMZM23600 can activate and affect the normal output voltage ramp up. In extreme cases, the [Hiccup Mode](#) operation can be activated during start-up if the maximum output capacitance is exceeded.

Refer to 表 5 for the minimum, recommended, and maximum output capacitance values for each output voltage. For this example with a 5-V output a 22- μF capacitor can be used.

表 5. Output Capacitor

OUTPUT VOLTAGE	MINIMUM OUTPUT CAPACITANCE	RECOMMENDED OUTPUT CAPACITANCE	MAXIMUM OUTPUT CAPACITANCE
1.2 V	82 μF	100 μF	470 μF
1.8 V	68 μF	82 μF	470 μF
2.5 V	47 μF	68 μF	390 μF
3.3 V	22 μF	33 μF	330 μF
5 V	15 μF	22 μF	220 μF
12 V	10 μF	15 μF	200 μF
15 V	10 μF	15 μF	200 μF

9.2.2.4 Feedback Voltage Divider for Adjustable Output Voltage Versions

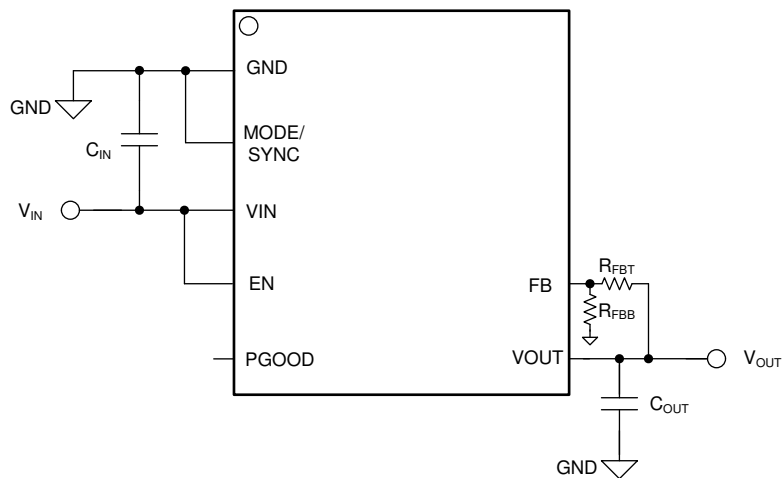

Copyright © 2017, Texas Instruments Incorporated

图 37. Adjustable 1.2-V to 15-V Output Typical Application Circuit

The adjustable version of the LMZM23600 regulates the output voltage such that the FB node voltage is equal to the internal V_{REF} voltage of 1 V. The output voltage is then set by a feedback voltage divider formed by two external resistors, R_{FBT} and R_{FBB} .

$$V_{\text{OUT}} = V_{\text{REF}} \times \frac{R_{\text{FBB}} + R_{\text{FBT}}}{R_{\text{FBB}}} \quad (1)$$

The range of adjustable output voltage is 1.2 V to 15 V.

Choose a value for R_{FBT} in the k Ω range, and calculate the bottom resistor R_{FBB} using 公式 2:

$$R_{\text{FBB}} = \frac{R_{\text{FBT}}}{\frac{V_{\text{OUT}}}{V_{\text{REF}}} - 1} \quad (2)$$

For $V_{\text{OUT}} < 3.0$ V it is recommended to allow 20 μA of static load current on the output. This can be achieved by limiting the maximum resistance of the feedback divider. For example, for $V_{\text{OUT}} = 2$ V, the maximum total feedback resistance ($R_{\text{FBB}} + R_{\text{FBT}}$) should be 100 k Ω or less.

For this design example the output voltage is set to 5 V. The fixed 5-V output voltage option of the LMZM23600 can be used without any feedback resistors. If the adjustable output option is used for this design condition, the top feedback resistor R_{FBT} can be set to 102 k Ω . The R_{FBB} value results in 25.5 k Ω .

9.2.2.5 R_{PU} - PGOOD Pullup Resistor

The PGOOD terminal of the LMZM23600 is an open-drain output. If the application requires a power-good flag, use a 100-k Ω pullup resistor from the PGOOD terminal to an external voltage rail. If a power-good function is not necessary, the PGOOD terminal can be left floating.

9.2.2.6 V_{IN} Divider and Enable

If the application requires custom input UVLO level higher than the internal UVLO, a voltage divider can be connected from V_{IN} to the EN terminal to set the turnon threshold.



图 38. Enable Divider to Set External UVLO Threshold

Choose the top resistor R_{ENB} between 10 k Ω and 50 k Ω and calculate the R_{ENT} according to [公式 3](#).

$$R_{ENT} = \left(\frac{V_{START}}{V_{EN}} - 1 \right) \times R_{ENB}$$

$$V_{STOP} = V_{START} \times \left(1 - \frac{V_{EN_HYST}}{V_{EN}} \right)$$

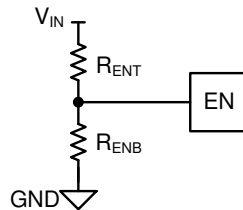
where

- V_{START} is the rising input voltage level at which switching starts. Choose this value based on the application requirements.
- V_{STOP} is the input voltage at which switching stops
- V_{EN} is the rising threshold on EN; see [Electrical Characteristics](#)
- V_{EN_HYST} is the hysteresis on the EN threshold; see [Electrical Characteristics](#)

(3)

9.2.3 Application Curves

Unless otherwise stated, the following conditions apply: $V_{IN} = 24\text{ V}$, $T_A = 25^\circ\text{C}$.

9.2.3.1 $V_{OUT} = 5\text{ V}$

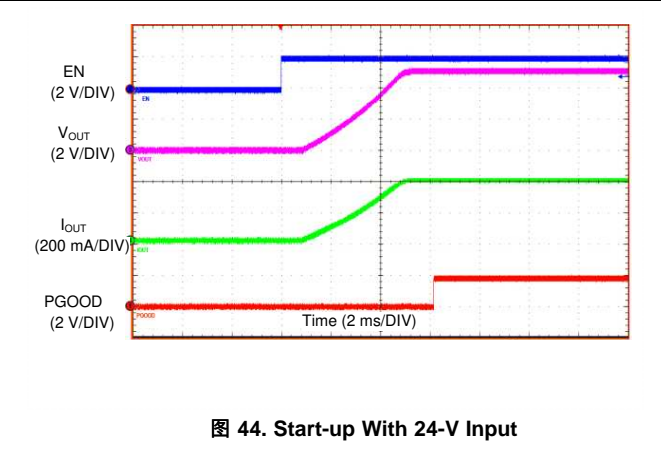
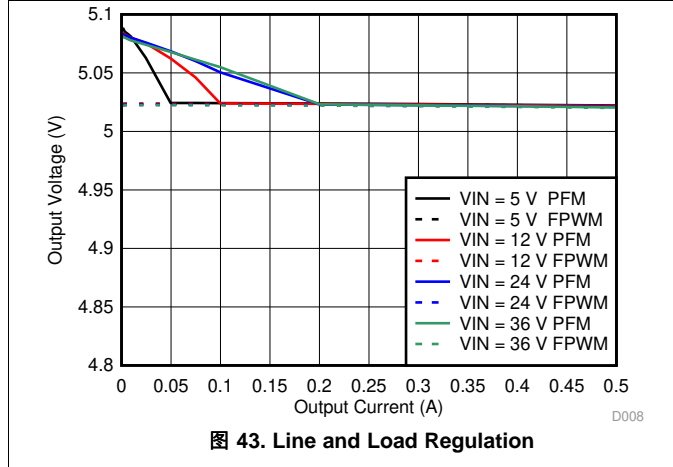
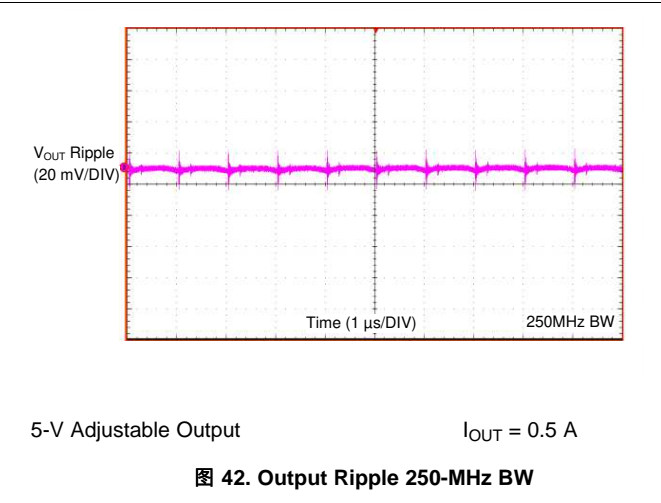
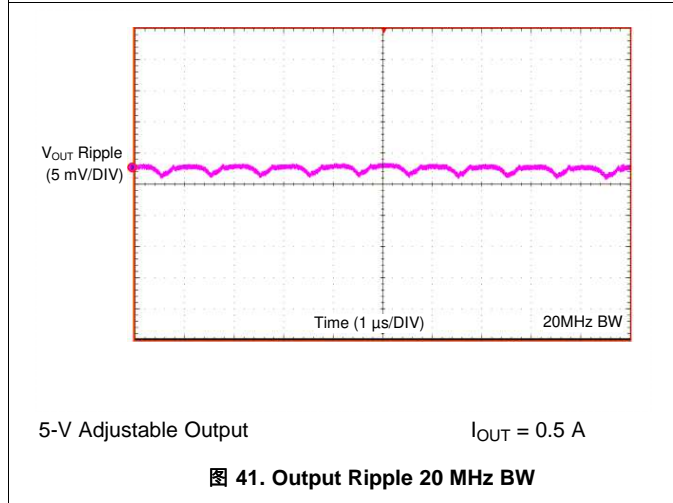
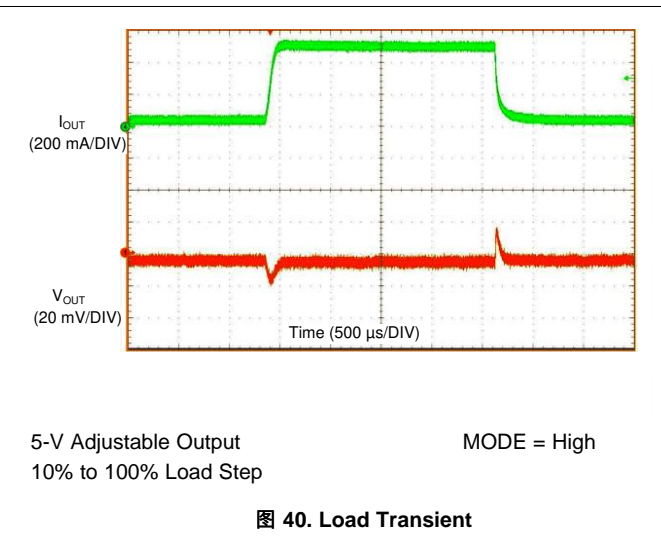
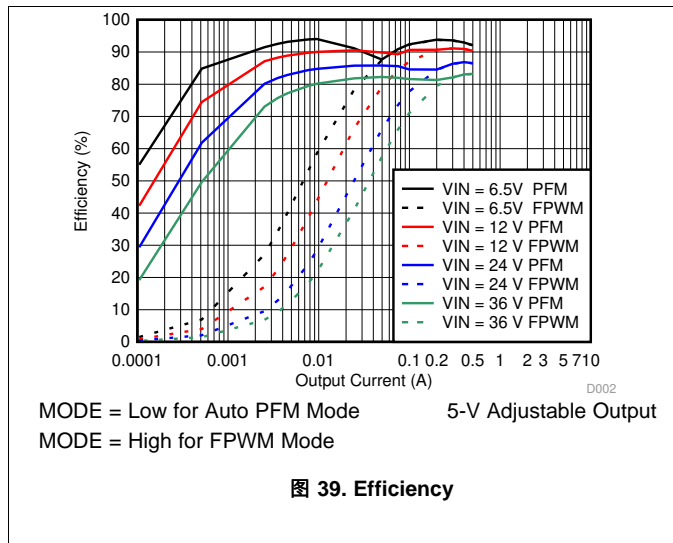

LMZM23600

ZHCSH00B – FEBRUARY 2018 – REVISED MAY 2019

www.ti.com.cn

9.2.3.2 $V_{OUT} = 3.3\text{ V}$

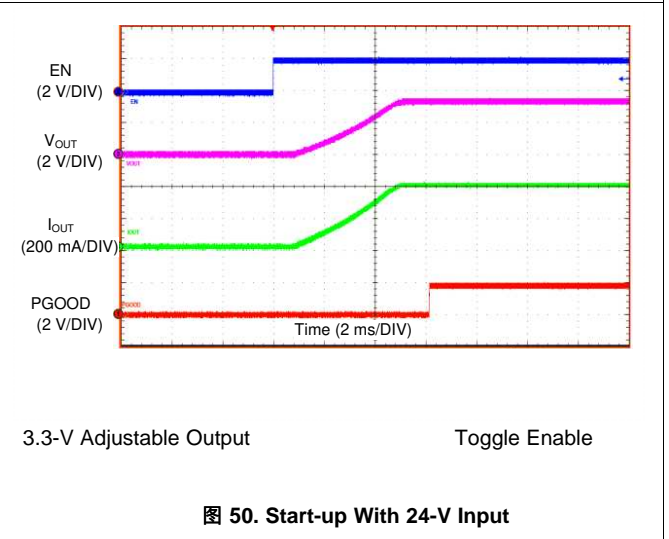
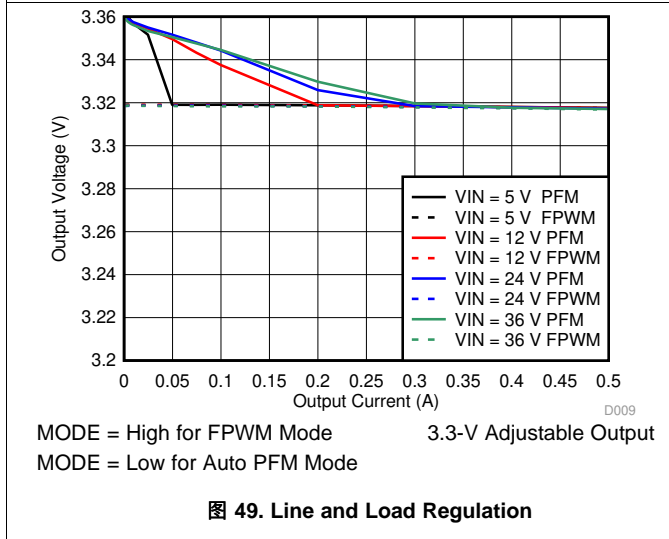
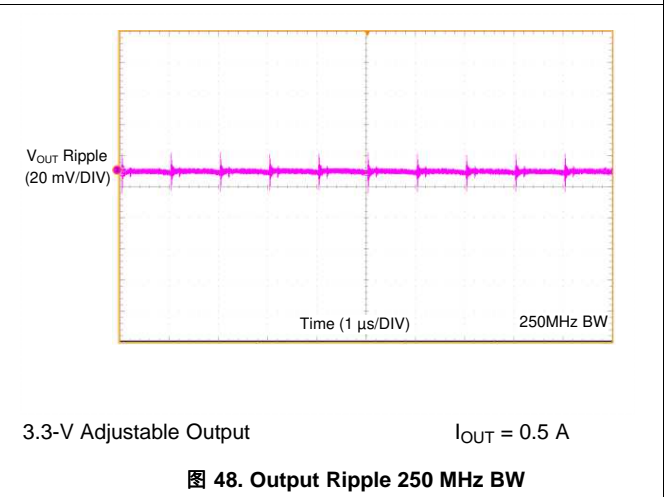
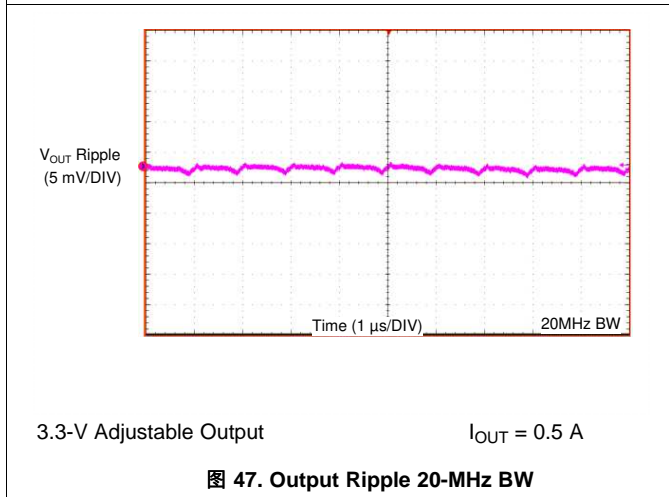
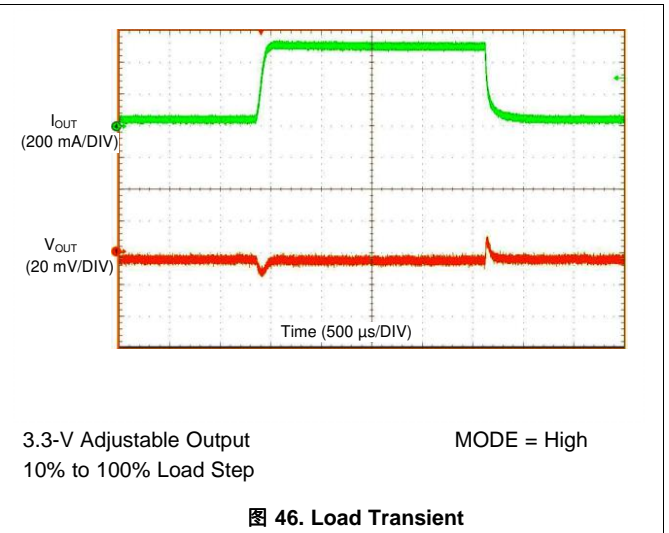
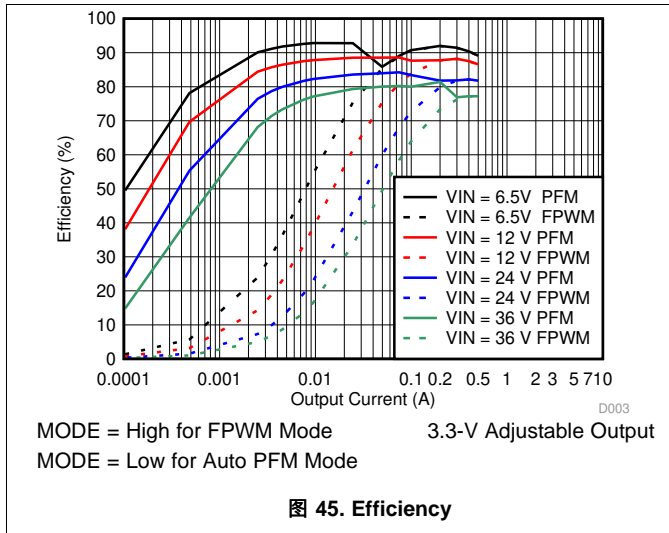

9.2.3.3 $V_{OUT} = 12\text{ V}$

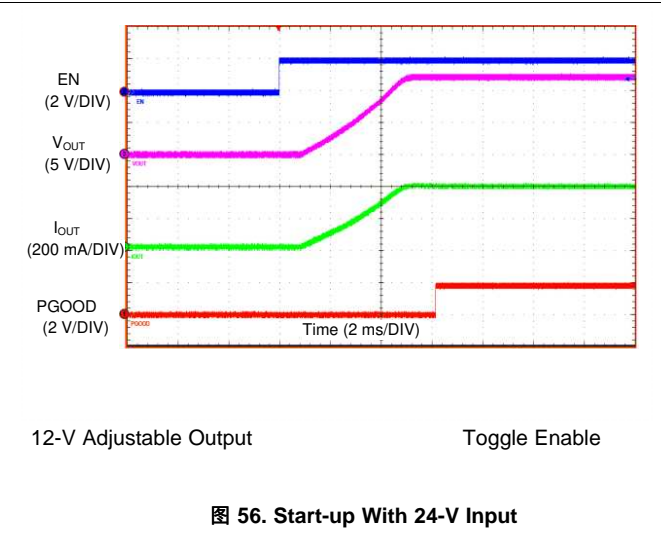
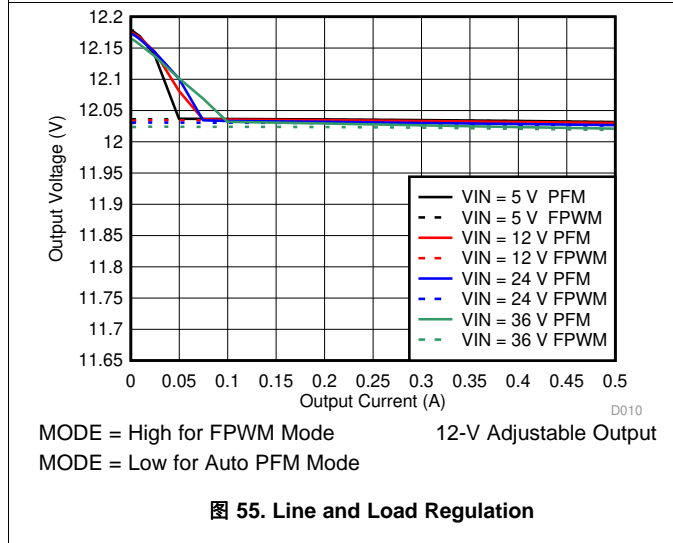
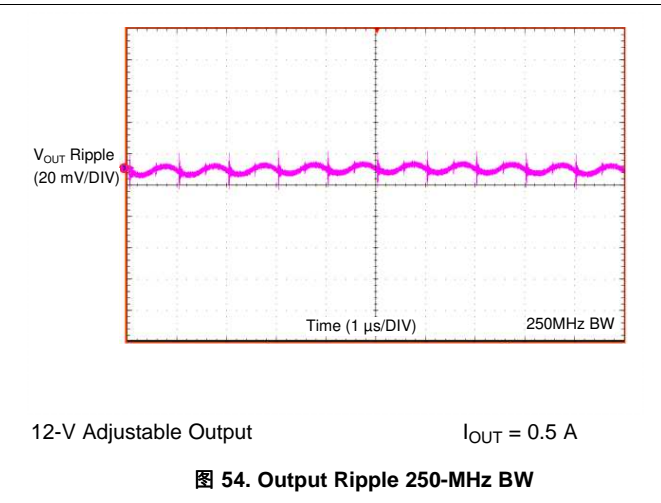
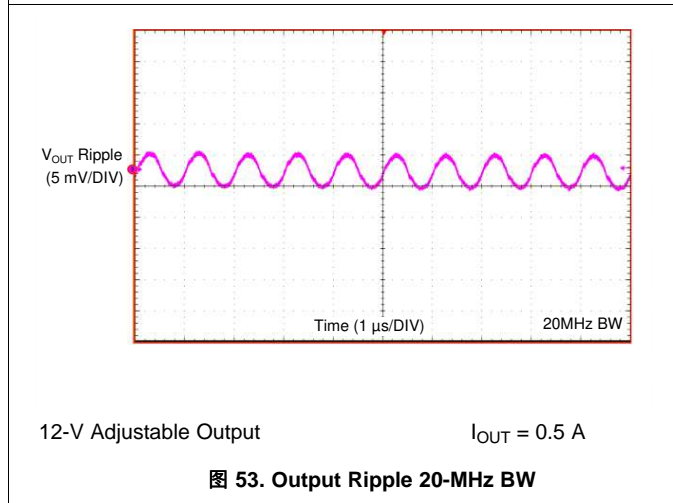
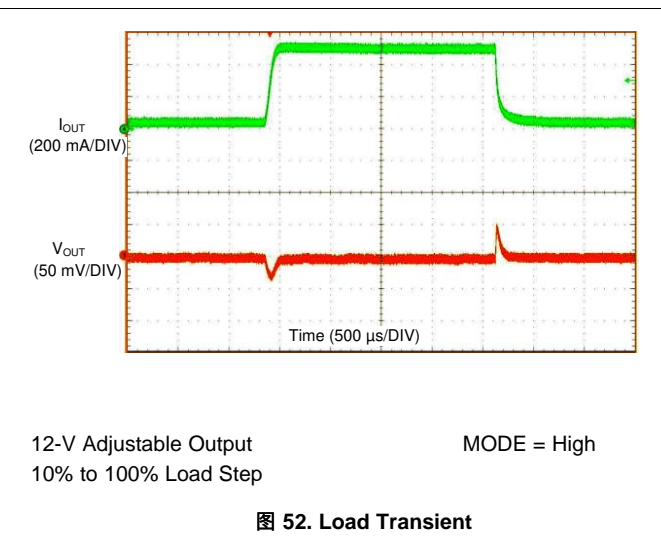
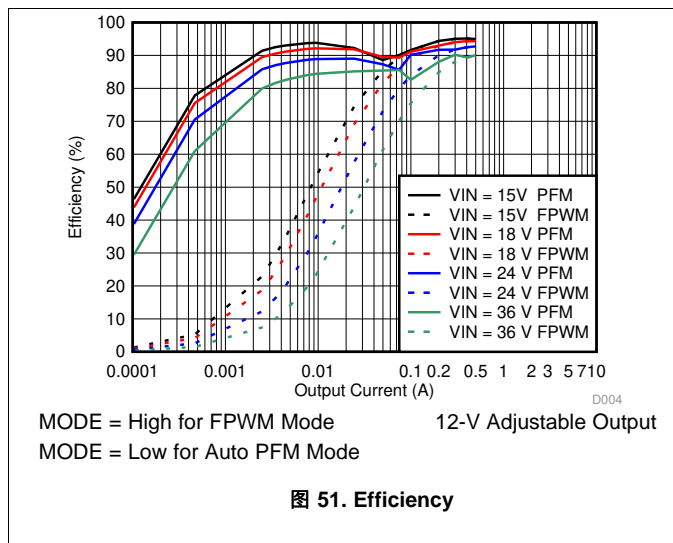

LMZM23600

ZHCSHO0B – FEBRUARY 2018 – REVISED MAY 2019

www.ti.com.cn

9.2.3.4 $V_{OUT} = 15\text{ V}$

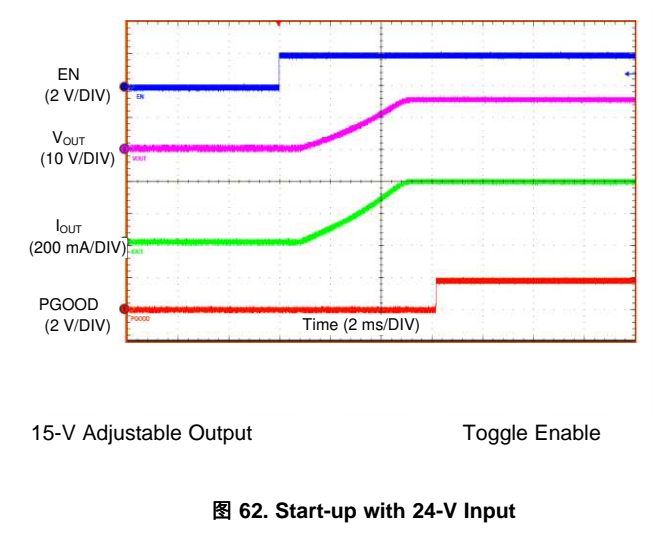
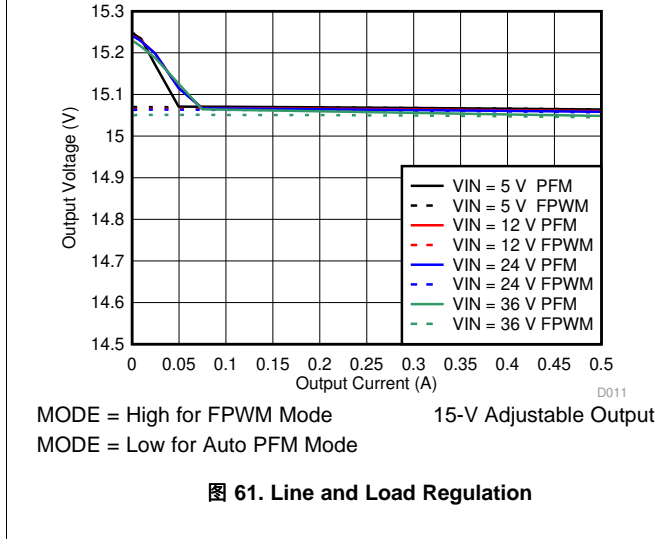
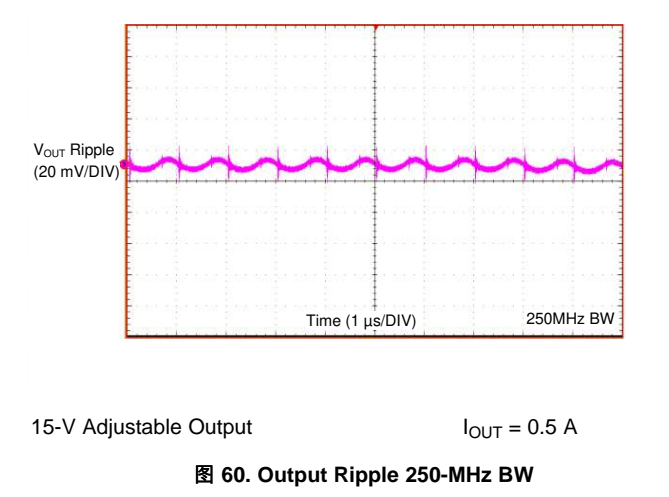
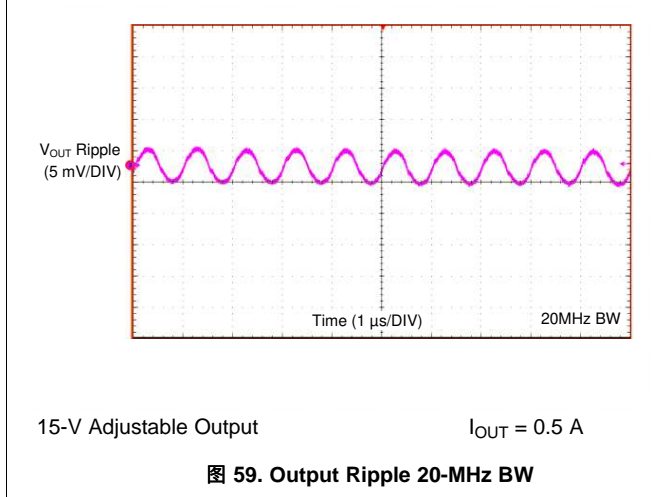
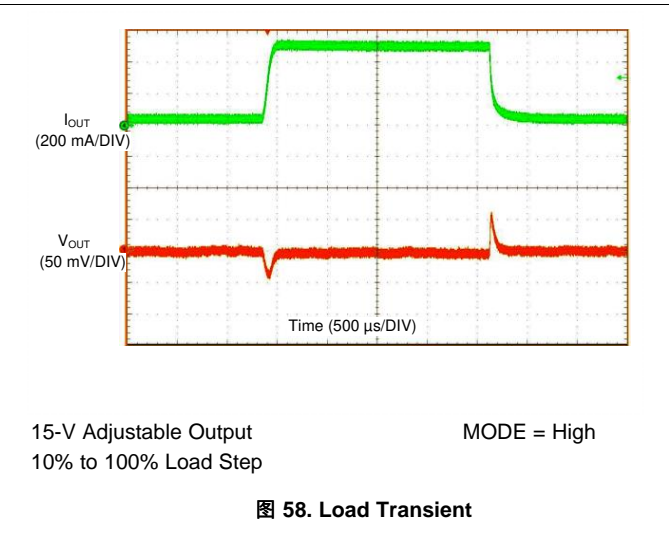
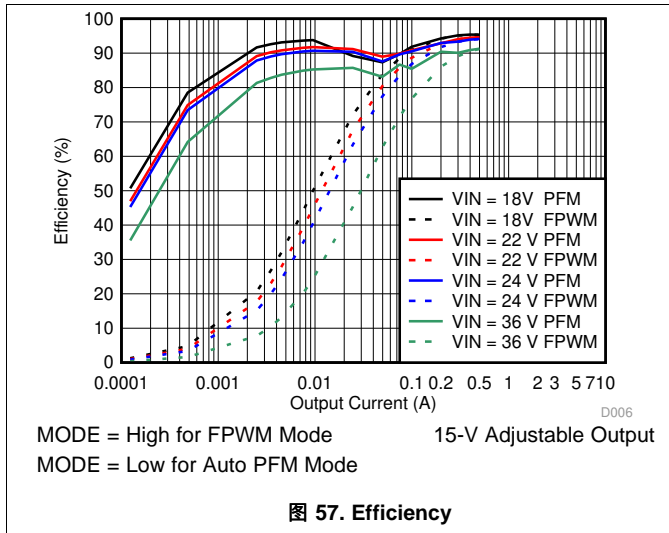

9.2.3.5 $V_{OUT} = 2.5\text{ V}$

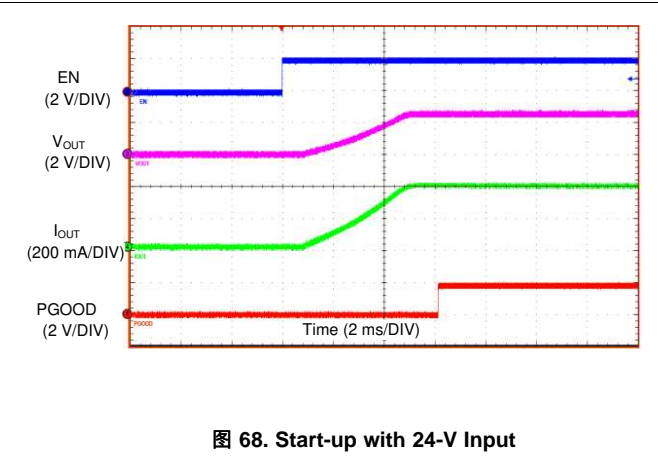
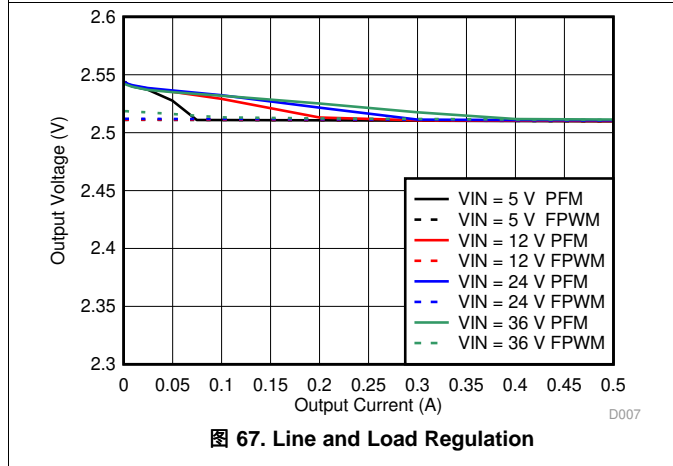
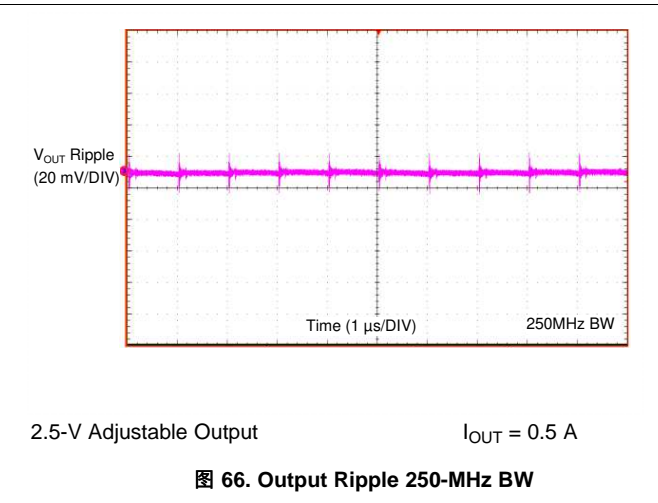
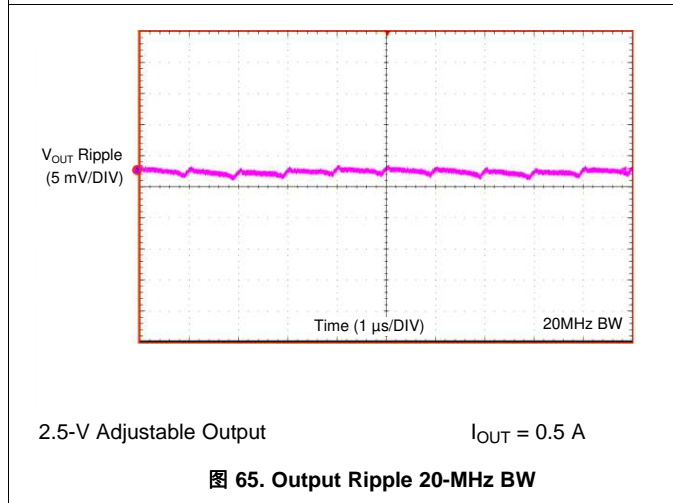
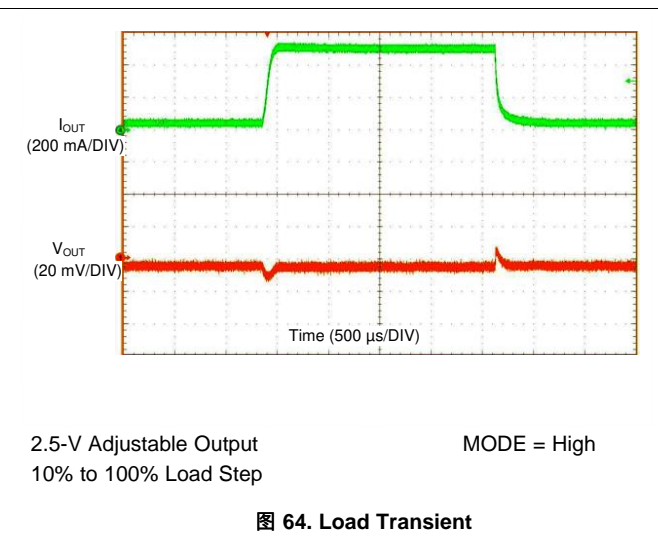
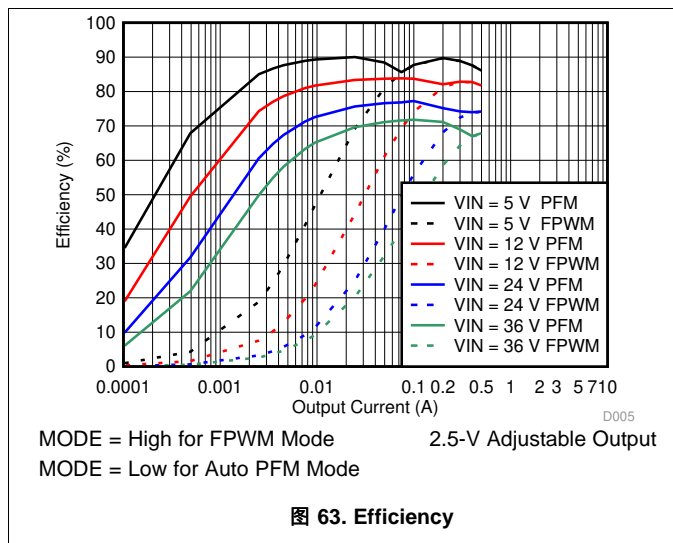

9.2.3.6 $V_{OUT} = 1.2\text{ V}$ and $V_{OUT} = 1.8\text{ V}$

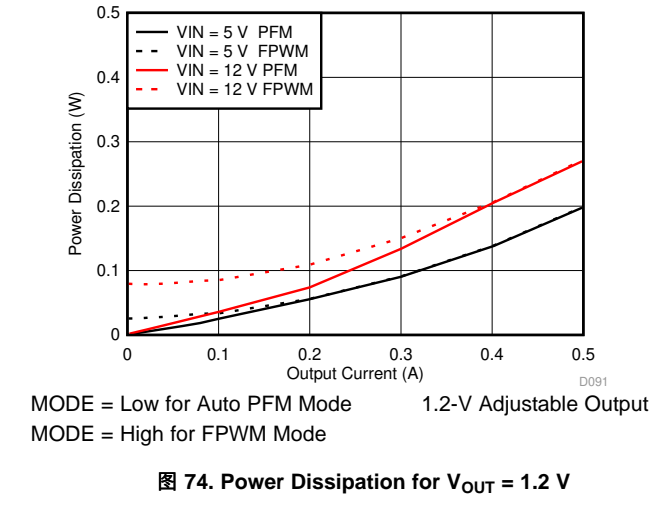
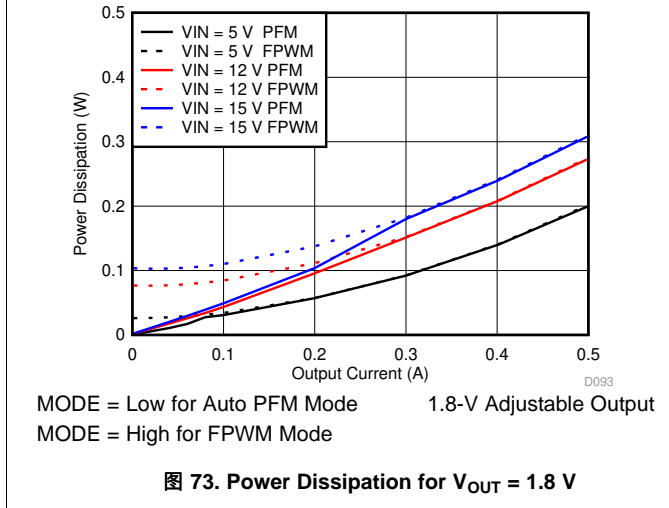
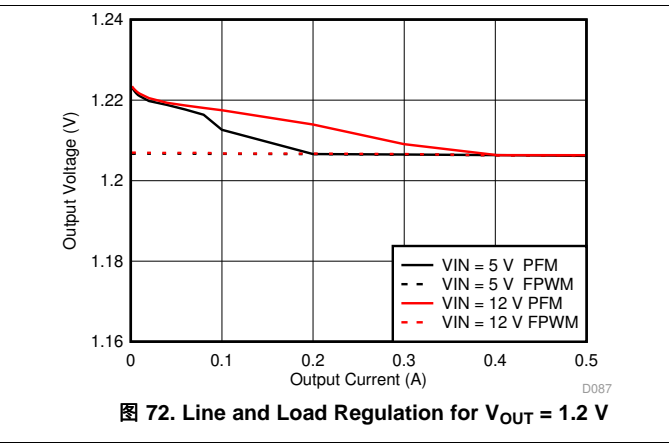
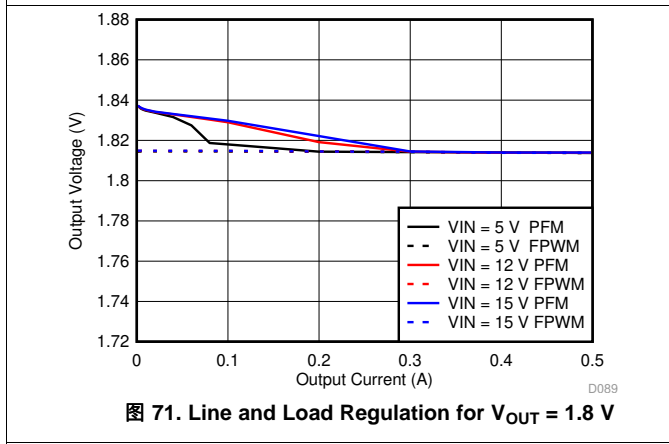
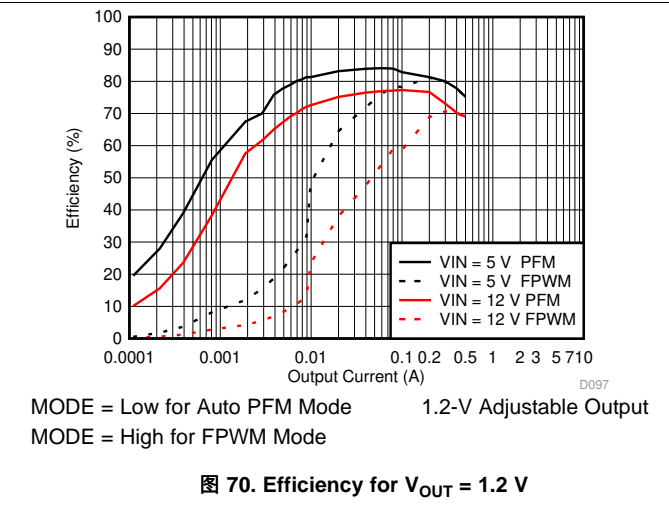
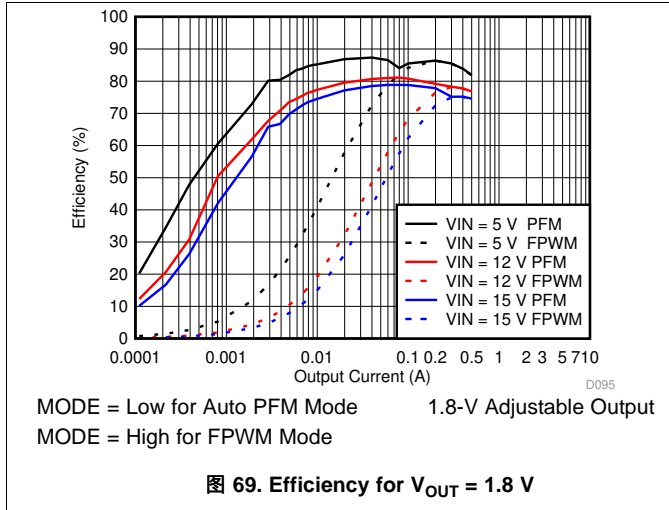

9.2.3.7 $V_{OUT} = 5\text{ V}$ and 3.3 V Fixed Output Options

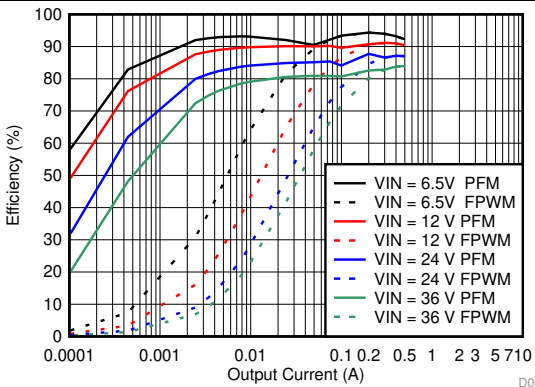

MODE = Low for Auto PFM Mode 5-V Fixed Output
MODE = High for FPWM Mode

图 75. Efficiency for $V_{OUT} = 5\text{ V}$

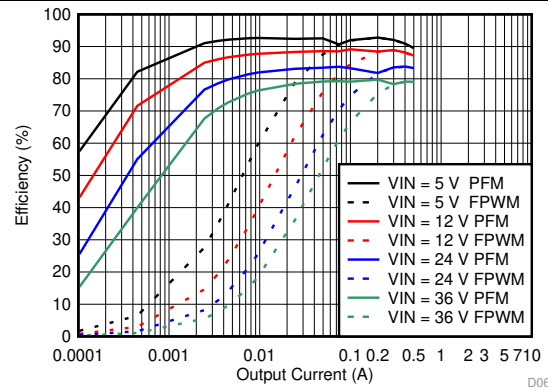

MODE = Low for Auto PFM Mode 3.3-V Fixed Output
MODE = High for FPWM Mode

图 76. Efficiency for $V_{OUT} = 3.3\text{ V}$



图 77. Line and Load Regulation for $V_{OUT} = 5\text{ V}$



图 78. Line and Load Regulation for $V_{OUT} = 3.3\text{ V}$

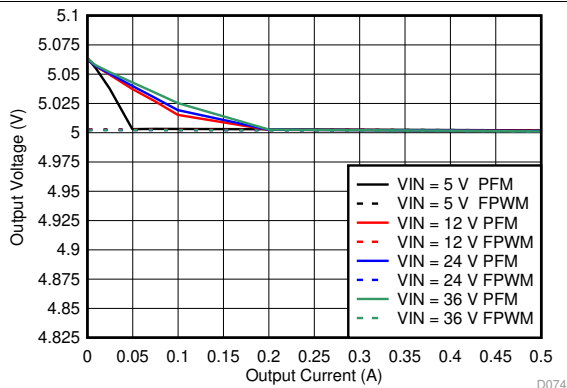

MODE = Low for Auto PFM Mode 5-V Fixed Output
MODE = High for FPWM Mode

图 79. Power Dissipation for $V_{OUT} = 5\text{ V}$

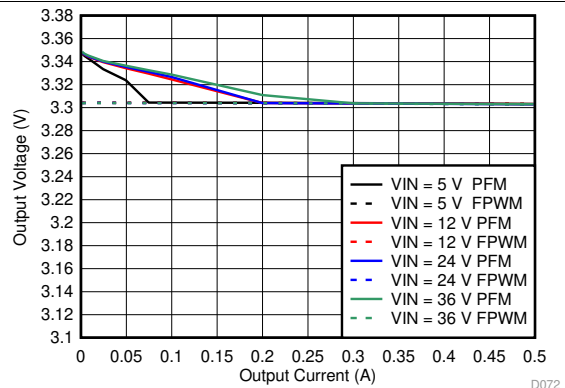
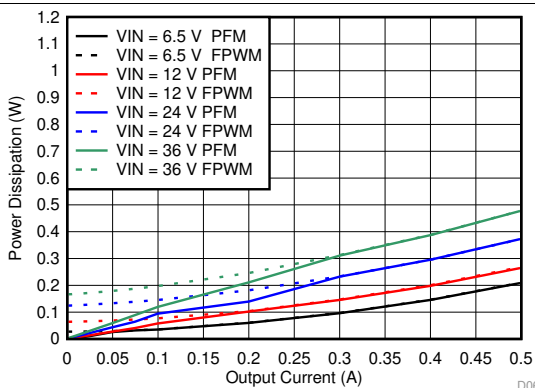
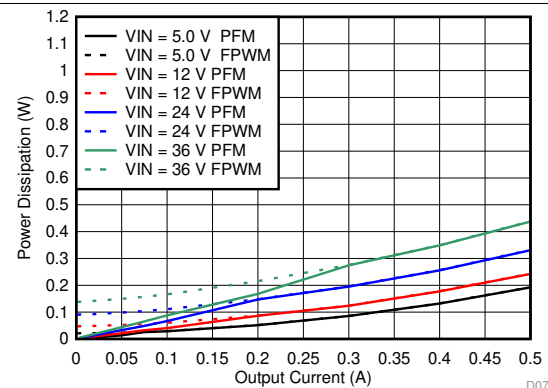

MODE = Low for Auto PFM Mode 3.3-V Fixed Output
MODE = High for FPWM Mode

图 80. Power Dissipation for $V_{OUT} = 3.3\text{ V}$

9.3 Do's and Don'ts

- Don't: Exceed the absolute maximum ratings of the device.
- Don't: Exceed the ESD ratings of the device.
- Don't: Exceed the recommended operating conditions.
- Don't: Allow the EN or MODE/SYNC terminals to float.
- Don't: Allow the output voltage to exceed the input voltage, nor go below ground.
- Do: Follow all of the guidelines and/or suggestions found in this data sheet, before committing your design to production.
- Do: Review your designs with TI Application Engineers on the [E2E forum](#).

10 Power Supply Recommendations

10.1 Supply Voltage Range

The voltage of the input supply must not exceed the absolute maximum ratings and the recommended operating conditions of the LMZM23600.

10.2 Supply Current Capability

The input supply must be able to supply the required input current to the LMZM23600 converter. The required input current depends on the application's minimum input voltage, the required maximum output current, the output voltage, and the converter efficiency η for this condition.

$$I_{IN} \geq \frac{V_{OUT} \times I_{OUTMAX}}{V_{INMIN} \times \eta} \quad (4)$$

As an example, assuming that the adjustable output voltage version of the LMZM23600 is used for a 5-V, 0.5-A output converter design with 12-V minimum input voltage. The conversion efficiency for this condition is about 85%. The required input current from the supply would be 0.49 A, so an input power supply with ≥ 0.5 A current capability would be recommended.

10.3 Supply Input Connections

Long input connection cables can cause issues with the normal operation of any buck converter. Some of the issues could be a voltage drop in the input voltage or stability probes because of the added series input inductance.

10.3.1 Voltage Drops

Using long input wires to connect the supply to the input of any converter adds impedance in series with the input supply. This impedance can cause a voltage drop at the VIN pin of the converter when the output of the converter is loaded. If the input voltage is near the minimum input operating voltage for the design, this added voltage drop can cause the converter to drop out or reset. If long wires are used during testing, TI recommends adding some bulk (for example, electrolytic) capacitance at the input of the converter.

10.3.2 Stability

The added inductance of long input cables together with the ceramic (and low ESR) input capacitor can result in an underdamped RLC network at the input of the buck converter. This circuit may cause instability, or overvoltage transients at the VIN pin each time the input supply is cycled on and off. If long wires are used, TI recommends adding some electrolytic bulk capacitance in parallel with the ceramic input capacitor. The ESR of the bulk capacitor improves the damping. Use an electrolytic capacitor with a capacitance at least four times larger than the ceramic input capacitance.

$$C_{BULK} \geq 4 \times C_{CER} \quad (5)$$

The required ESR from the bulk capacitor depends on the cable inductance.

$$ESR_{BULK} \geq \sqrt{\frac{L_{CABLE}}{C_{CER}}} \quad (6)$$

For example, two cables (one for VIN and one for GND), each 1 meter (approximately 3 feet) long with approximately 1-mm diameter (18 AWG), placed 1 cm (approximately 0.4 inch) apart forms a rectangular loop resulting in about 1.2 μ H of inductance. The inductance in this example can be decreased to almost half if the input wires are twisted. Based on a 10- μ F ceramic input capacitor, the recommended parallel C_{BULK} is ≥ 40 μ F. Using a 47- μ F capacitor is sufficient. Based on about 1.2 μ H of inductance and 10 μ F of ceramic input capacitance, the recommended ESR of the bulk capacitor is 0.35 Ω or larger. See [TI User Guide, Simple Success with Conducted EMI for DC/DC Converters](#) for more details on input filter design.

11 Layout

11.1 Layout Guidelines

Good board layout is essential for the proper operation of any switching regulator. A poor layout can ruin an otherwise perfect schematic design. The good news is that it is relatively easy to achieve an optimized layout when using a module because some of the critical nodes for the board layout are internal to the device. To have a good layout with this module, the designer should follow these main objectives:

1. *Minimize the inductance in the switching current path of the converter.* The switching current path in the buck converter is formed by the input capacitor and the power switches (for example, MOSFETs). A **common mistake** in many buck converter layouts is placing the input capacitor far from the IC. This introduces inductance in the switching current path, which leads to high frequency ringing on the switching node, which results in high frequency noise coupled all the way to the output voltage. The **input capacitor** placement affects the amount of **noise on the output** in a buck converter. Place the input capacitor as close as possible, right next to the LMZM23600 ensures that the switching current path area is kept to a minimum. This results in the lowest possible inductance in the path of high di/dt current.
2. *Protect any sensitive nodes in the converter design.* The feedback node is usually a sensitive area of the converter and needs to be away from any noise sources. The fixed 5-V and 3.3-V output voltage versions of the LMZM23600 have the feedback resistors internal to the device, and the sensitive node is inside the module. However, if the adjustable option is used, then two feedback resistors are required to set the output voltage. A **common mistake** in many layouts is placing the divider close to the load, far from the device, and then using a long feedback trace back to the regulator. A long feedback trace can potentially pick up noise from other nearby circuits. TI recommends placing the feedback divider as close as possible to the LMZM23600 device so that the feedback node is as small as possible.
3. *Provide enough copper for heat dissipation.* The board copper provides a thermal resistance path for the heat to flow out of the package and dissipate into the environment. Place a *dog-bone* shape of ground (GND) copper under the module for proper heat sinking. Also, place thermal vias to provide a heat path to the other board layers. TI recommends an unbroken GND plane or GND area of copper on the top and bottom layers.

11.1.1 Thermal Design

Thermal design is an important aspect of any power regulator design. Every supply will dissipate some power, and it is important to provide sufficient copper area for proper heat dissipation. The package thermal resistance curves vs PCB copper area along with the power dissipation curves in [Typical Characteristics](#) can be used to estimate the necessary copper area for the design. Consider [公式 7](#) and [图 81](#).

$$R_{\theta} \leq \frac{125^{\circ}\text{C} - T_{A_MAX}}{P_D} \quad (7)$$



图 81. Package Thermal Resistance vs Board Copper Area

Layout Guidelines (接下页)

As an example, consider a typical application of 24-V input 5-V output with 0.5 A of output current and estimate the required heat-sinking area. For this example consider a maximum ambient temperature T_{A_MAX} of 95°C and no air flow or additional heat sinking besides the PCB layers. Calculate the maximum allowed package thermal resistance for this design specification.

From *Typical Characteristics*, it can be seen that the power dissipation for 24-V input, 5-V output, and 0.5A load is 0.4 W. Based on 公式 7, for this power dissipation level and 95°C maximum ambient temperature, the maximum package thermal resistance must be less than 75°C/W. To achieve this thermal resistance with a 2-layer board, the approximate area of the board copper should be at least 5 cm².

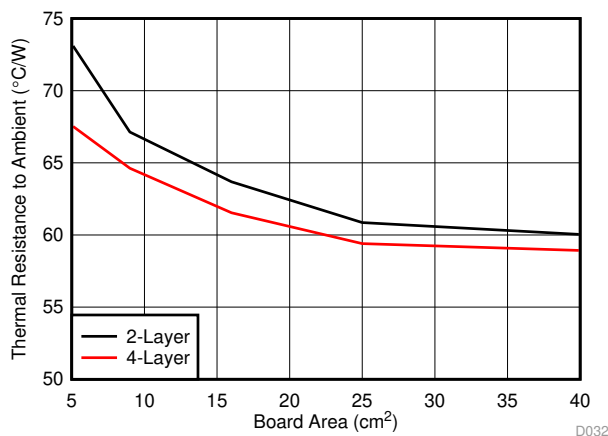
11.2 Layout Examples



图 82. Layout Example With Fixed Output Version

Layout Examples (接下页)

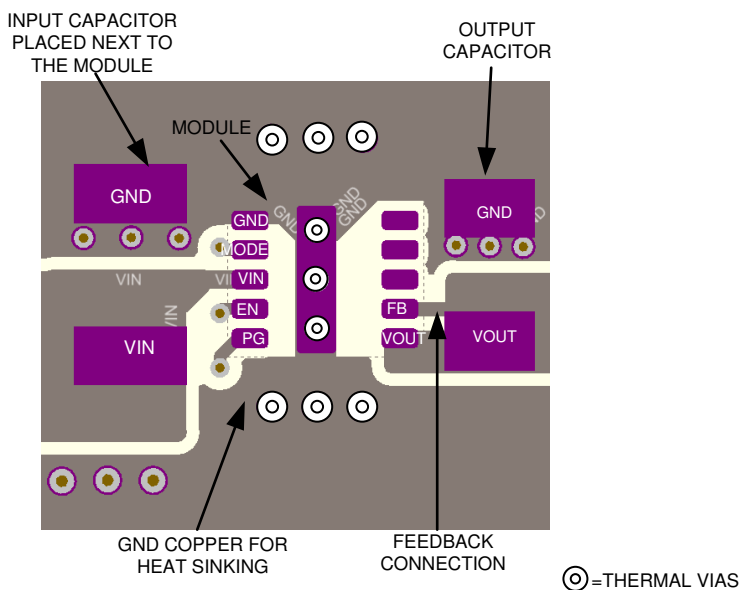

图 83. Layout Example With Adjustable Output Version

12 器件和文档支持

12.1 器件支持

12.1.1 第三方产品免责声明

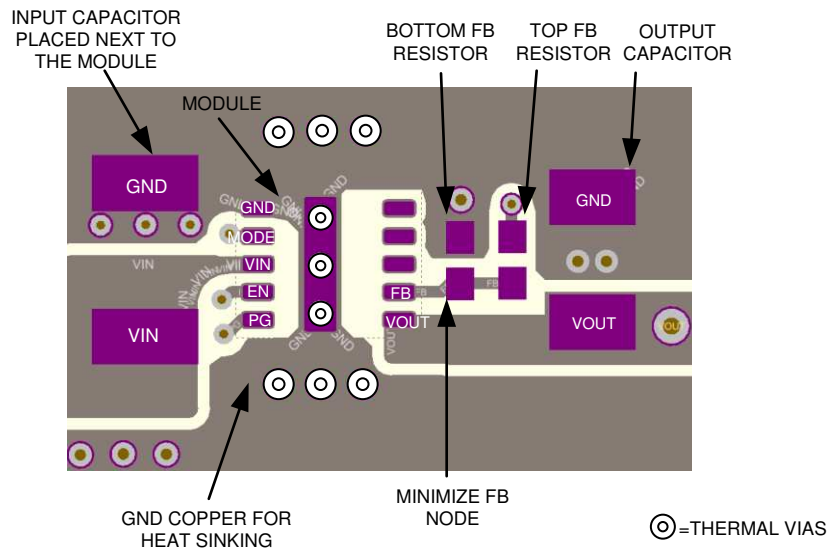
TI 发布的与第三方产品或服务有关的信息，不能构成与此类产品或服务或保修的适用性有关的认可，不能构成此类产品或服务单独或与任何 TI 产品或服务一起的表示或认可。

12.2 使用 WEBENCH® 工具创建定制设计

单击[此处](#)，使用 LMZM23600 器件和 WEBENCH® 电源设计器创建定制设计方案。

1. 首先输入输入电压 (V_{IN})、输出电压 (V_{OUT}) 和输出电流 (I_{OUT}) 要求。
2. 使用优化器拨盘优化该设计的关键参数，如效率、尺寸和成本。
3. 将生成的设计与德州仪器 (TI) 的其他可行的解决方案进行比较。

WEBENCH 电源设计器可提供定制原理图以及罗列实时价格和组件供货情况的物料清单。

在多数情况下，可执行以下操作：

- 运行电气仿真，观察重要波形以及电路性能
- 运行热性能仿真，了解电路板热性能
- 将定制原理图和布局方案以常用 CAD 格式导出
- 打印设计方案的 PDF 报告并与同事共享

有关 WEBENCH 工具的详细信息，请访问 www.ti.com.cn/WEBENCH。

12.3 文档支持

12.3.1 相关文档

相关文档如下：

《LMZM23601 和 LMZM23600 的反向应用》

《AN-2020 热设计：学会洞察先机，不做事后诸葛》

《AN-1149 开关电源布局指南》

《构建电源 - 布局注意事项》

《AN-1229 Simple Switcher PCB 布局指南》(SNVA054)

《使用新的热指标》

《半导体和 IC 封装热指标》

AN-1520 《外露焊盘封装实现最佳热阻性的电路板布局指南》

TI 用户指南 《直流/直流转换器的传导 EMI 的简单成功案例》

12.4 接收文档更新通知

要接收文档更新通知，请导航至 TI.com.cn 上的器件产品文件夹。单击右上角的通知我 进行注册，即可每周接收产品信息更改摘要。有关更改的详细信息，请查看任何已修订文档中包含的修订历史记录。

12.5 社区资源

The following links connect to TI community resources. Linked contents are provided "AS IS" by the respective contributors. They do not constitute TI specifications and do not necessarily reflect TI's views; see TI's [Terms of Use](#).

TI E2E™ Online Community *TI's Engineer-to-Engineer (E2E) Community*. Created to foster collaboration among engineers. At e2e.ti.com, you can ask questions, share knowledge, explore ideas and help solve problems with fellow engineers.

Design Support *TI's Design Support* Quickly find helpful E2E forums along with design support tools and

社区资源 (接下页)

contact information for technical support.

12.6 商标

MicroSiP, E2E are trademarks of Texas Instruments.
 WEBENCH is a registered trademark of Texas Instruments.
 All other trademarks are the property of their respective owners.

12.7 静电放电警告



这些装置包含有限的内置 ESD 保护。存储或装卸时，应将导线一起截短或将装置放置于导电泡棉中，以防止 MOS 门极遭受静电损伤。

12.8 Glossary

SLYZ022 — TI Glossary.

This glossary lists and explains terms, acronyms, and definitions.

13 机械、封装和可订购信息

以下页面包含机械、封装和可订购信息。这些信息是指定器件的最新可用数据。数据如有变更，恕不另行通知，且不会对此文档进行修订。如需获取此数据表的浏览器版本，请查阅左侧的导航栏。

13.1 Tape and Reel Information

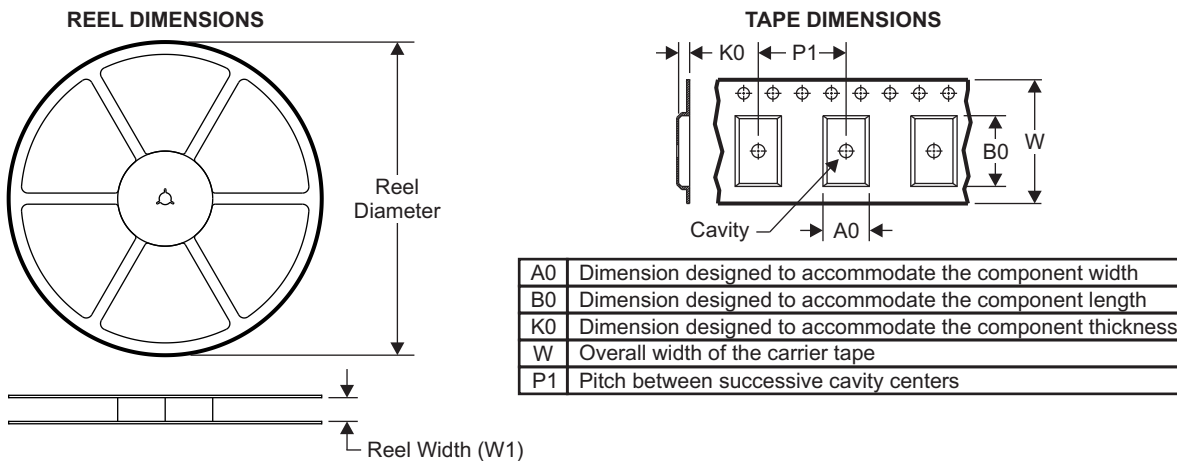

QUADRANT ASSIGNMENTS FOR PIN 1 ORIENTATION IN TAPE

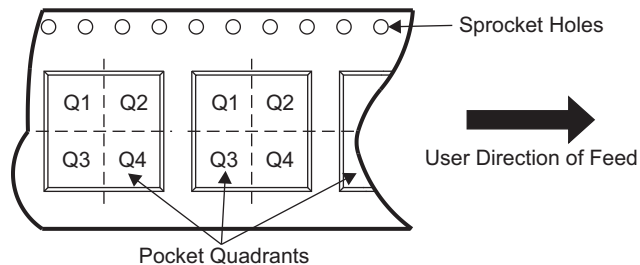

Device	Package Type	Package Drawing	Pins	SPQ	Reel Diameter (mm)	Reel Width W1 (mm)	A0 (mm)	B0 (mm)	K0 (mm)	P1 (mm)	W (mm)	Pin1 Quadrant
LMZM23600SILR	uSiP	SIL	10	3000	330.0	12.4	3.27	4.07	1.78	8.0	12.0	Q2
LMZM23600SILT	uSiP	SIL	10	250	330.0	12.4	3.27	4.07	1.78	8.0	12.0	Q2
LMZM23600V3SILR	uSiP	SIL	10	3000	330.0	12.4	3.27	4.07	1.78	8.0	12.0	Q2
LMZM23600V3SILT	uSiP	SIL	10	250	330.0	12.4	3.27	4.07	1.78	8.0	12.0	Q2

Tape and Reel Information (接下页)

Device	Package Type	Package Drawing	Pins	SPQ	Reel Diameter (mm)	Reel Width W1 (mm)	A0 (mm)	B0 (mm)	K0 (mm)	P1 (mm)	W (mm)	Pin1 Quadrant
LMZM23600V5SILR	uSiP	SIL	10	3000	330.0	12.4	3.27	4.07	1.78	8.0	12.0	Q2
LMZM23600V5SILT	uSiP	SIL	10	250	330.0	12.4	3.27	4.07	1.78	8.0	12.0	Q2

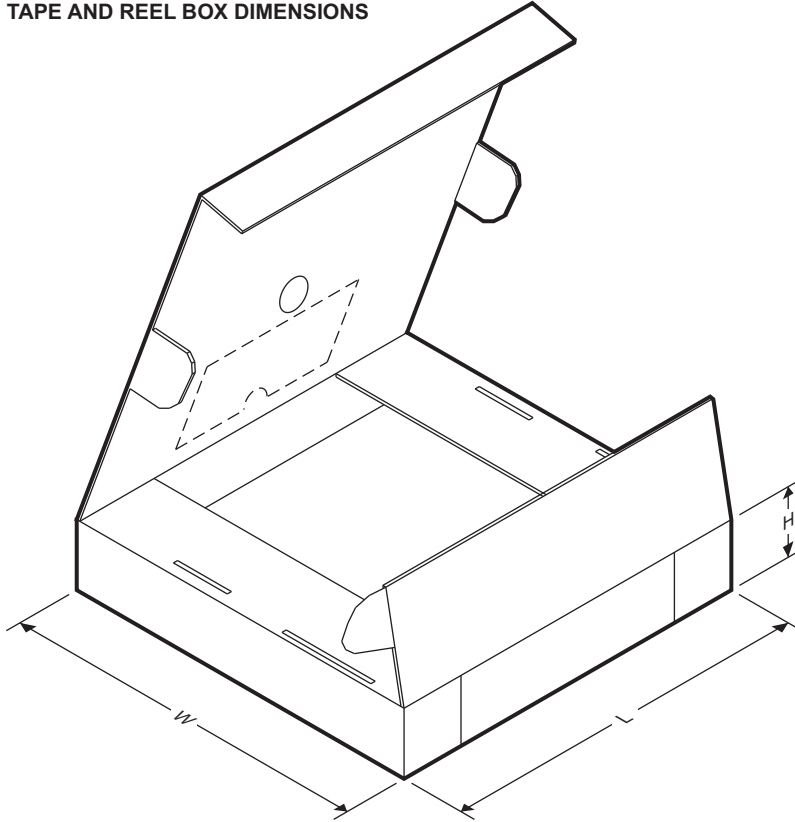
TAPE AND REEL BOX DIMENSIONS

Device	Package Type	Package Drawing	Pins	SPQ	Length (mm)	Width (mm)	Height (mm)
LMZM23600SILR	uSiP	SIL	10	3000	383.0	353.0	58.0
LMZM23600SILT	uSiP	SIL	10	250	383.0	353.0	58.0
LMZM23600V3SILR	uSiP	SIL	10	3000	383.0	353.0	58.0
LMZM23600V3SILT	uSiP	SIL	10	250	383.0	353.0	58.0
LMZM23600V5SILR	uSiP	SIL	10	3000	383.0	353.0	58.0
LMZM23600V5SILT	uSiP	SIL	10	250	383.0	353.0	58.0

重要声明和免责声明

TI 均以“原样”提供技术性数据（包括数据表）、设计资源（包括参考设计）、应用或其他设计建议、网络工具、安全信息和其他资源，不保证其中不含任何瑕疵，且不做任何明示或暗示的担保，包括但不限于对适销性、适合某特定用途或不侵犯任何第三方知识产权的暗示担保。

所述资源可供专业开发人员应用TI 产品进行设计使用。您将对以下行为独自承担全部责任：(1) 针对您的应用选择合适的TI 产品；(2) 设计、验证并测试您的应用；(3) 确保您的应用满足相应标准以及任何其他安全、安保或其他要求。所述资源如有变更，恕不另行通知。TI 对您使用所述资源的授权仅限于开发资源所涉及TI 产品的相关应用。除此之外不得复制或展示所述资源，也不提供其它TI 或任何第三方的知识产权授权许可。如因使用所述资源而产生任何索赔、赔偿、成本、损失及债务等，TI 对此概不负责，并且您须赔偿由此对TI 及其代表造成的损害。

TI 所提供产品均受TI 的销售条款 (<http://www.ti.com.cn/zh-cn/legal/termsofsale.html>) 以及ti.com.cn上或随附TI产品提供的其他可适用条款的约束。TI提供所述资源并不扩展或以其他方式更改TI 针对TI 产品所发布的可适用的担保范围或担保免责声明。

邮寄地址：上海市浦东新区世纪大道 1568 号中建大厦 32 楼，邮政编码：200122
Copyright © 2020 德州仪器半导体技术（上海）有限公司

PACKAGING INFORMATION

Orderable Device	Status (1)	Package Type	Package Drawing	Pins	Package Qty	Eco Plan (2)	Lead finish/ Ball material (6)	MSL Peak Temp (3)	Op Temp (°C)	Device Marking (4/5)	Samples
LMZM23600SILR	ACTIVE	uSiP	SIL	10	3000	RoHS & Green	NIAU	Level-3-260C-168 HR	-40 to 125	A 4J	Samples
LMZM23600SILT	ACTIVE	uSiP	SIL	10	250	RoHS & Green	NIAU	Level-3-260C-168 HR	-40 to 125	A 4J	Samples
LMZM23600V3SILR	ACTIVE	uSiP	SIL	10	3000	RoHS & Green	NIAU	Level-3-260C-168 HR	-40 to 125	A 4L	Samples
LMZM23600V3SILT	ACTIVE	uSiP	SIL	10	250	RoHS & Green	NIAU	Level-3-260C-168 HR	-40 to 125	A 4L	Samples
LMZM23600V5SILR	ACTIVE	uSiP	SIL	10	3000	RoHS & Green	NIAU	Level-3-260C-168 HR	-40 to 125	A 4K	Samples
LMZM23600V5SILT	ACTIVE	uSiP	SIL	10	250	RoHS & Green	NIAU	Level-3-260C-168 HR	-40 to 125	A 4K	Samples

(1) The marketing status values are defined as follows:

ACTIVE: Product device recommended for new designs.

LIFEBUY: TI has announced that the device will be discontinued, and a lifetime-buy period is in effect.

NRND: Not recommended for new designs. Device is in production to support existing customers, but TI does not recommend using this part in a new design.

PREVIEW: Device has been announced but is not in production. Samples may or may not be available.

OBSOLETE: TI has discontinued the production of the device.

(2) **RoHS:** TI defines "RoHS" to mean semiconductor products that are compliant with the current EU RoHS requirements for all 10 RoHS substances, including the requirement that RoHS substance do not exceed 0.1% by weight in homogeneous materials. Where designed to be soldered at high temperatures, "RoHS" products are suitable for use in specified lead-free processes. TI may reference these types of products as "Pb-Free".

RoHS Exempt: TI defines "RoHS Exempt" to mean products that contain lead but are compliant with EU RoHS pursuant to a specific EU RoHS exemption.

Green: TI defines "Green" to mean the content of Chlorine (Cl) and Bromine (Br) based flame retardants meet JS709B low halogen requirements of <=1000ppm threshold. Antimony trioxide based flame retardants must also meet the <=1000ppm threshold requirement.

(3) MSL, Peak Temp. - The Moisture Sensitivity Level rating according to the JEDEC industry standard classifications, and peak solder temperature.

(4) There may be additional marking, which relates to the logo, the lot trace code information, or the environmental category on the device.

(5) Multiple Device Markings will be inside parentheses. Only one Device Marking contained in parentheses and separated by a "~" will appear on a device. If a line is indented then it is a continuation of the previous line and the two combined represent the entire Device Marking for that device.

(6) Lead finish/Ball material - Orderable Devices may have multiple material finish options. Finish options are separated by a vertical ruled line. Lead finish/Ball material values may wrap to two lines if the finish value exceeds the maximum column width.

Important Information and Disclaimer: The information provided on this page represents TI's knowledge and belief as of the date that it is provided. TI bases its knowledge and belief on information provided by third parties, and makes no representation or warranty as to the accuracy of such information. Efforts are underway to better integrate information from third parties. TI has taken and continues to take reasonable steps to provide representative and accurate information but may not have conducted destructive testing or chemical analysis on incoming materials and chemicals. TI and TI suppliers consider certain information to be proprietary, and thus CAS numbers and other limited information may not be available for release.

In no event shall TI's liability arising out of such information exceed the total purchase price of the TI part(s) at issue in this document sold by TI to Customer on an annual basis.

TAPE AND REEL INFORMATION

QUADRANT ASSIGNMENTS FOR PIN 1 ORIENTATION IN TAPE

*All dimensions are nominal

Device	Package Type	Package Drawing	Pins	SPQ	Reel Diameter (mm)	Reel Width W1 (mm)	A0 (mm)	B0 (mm)	K0 (mm)	P1 (mm)	W (mm)	Pin1 Quadrant
LMZM23600SILR	uSiP	SIL	10	3000	330.0	12.4	3.27	4.07	1.78	8.0	12.0	Q2
LMZM23600SILT	uSiP	SIL	10	250	178.0	13.2	3.27	4.07	1.78	8.0	12.0	Q2
LMZM23600V3SILR	uSiP	SIL	10	3000	330.0	12.4	3.27	4.07	1.78	8.0	12.0	Q2
LMZM23600V3SILT	uSiP	SIL	10	250	178.0	13.2	3.27	4.07	1.78	8.0	12.0	Q2
LMZM23600V5SILR	uSiP	SIL	10	3000	330.0	12.4	3.27	4.07	1.78	8.0	12.0	Q2
LMZM23600V5SILT	uSiP	SIL	10	250	178.0	13.2	3.27	4.07	1.78	8.0	12.0	Q2

TAPE AND REEL BOX DIMENSIONS

*All dimensions are nominal

Device	Package Type	Package Drawing	Pins	SPQ	Length (mm)	Width (mm)	Height (mm)
LMZM23600SILR	uSiP	SIL	10	3000	383.0	353.0	58.0
LMZM23600SILT	uSiP	SIL	10	250	223.0	194.0	35.0
LMZM23600V3SILR	uSiP	SIL	10	3000	383.0	353.0	58.0
LMZM23600V3SILT	uSiP	SIL	10	250	223.0	194.0	35.0
LMZM23600V5SILR	uSiP	SIL	10	3000	383.0	353.0	58.0
LMZM23600V5SILT	uSiP	SIL	10	250	223.0	194.0	35.0

This image is a representation of the package family, actual package may vary.
Refer to the product data sheet for package details.

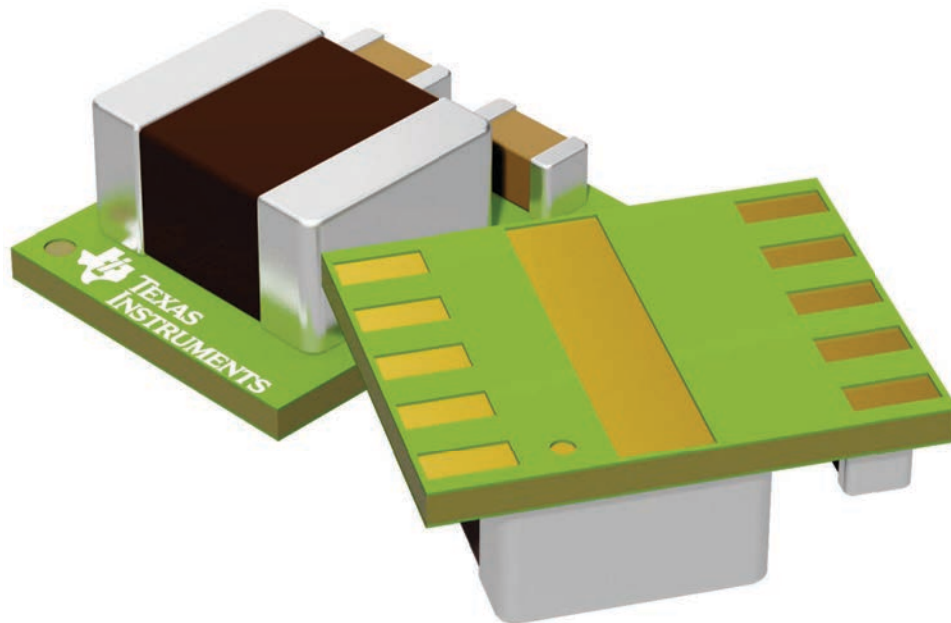

重要声明和免责声明

TI 提供技术和可靠性数据（包括数据表）、设计资源（包括参考设计）、应用或其他设计建议、网络工具、安全信息和其他资源，不保证没有瑕疵且不做任何明示或暗示的担保，包括但不限于对适销性、某特定用途方面的适用性或不侵犯任何第三方知识产权的暗示担保。

这些资源可供使用 TI 产品进行设计的熟练开发人员使用。您将自行承担以下全部责任：(1) 针对您的应用选择合适的 TI 产品，(2) 设计、验证并测试您的应用，(3) 确保您的应用满足相应标准以及任何其他安全、安保或其他要求。这些资源如有变更，恕不另行通知。TI 授权您仅可将这些资源用于研发本资源所述的 TI 产品的应用。严禁对这些资源进行其他复制或展示。您无权使用任何其他 TI 知识产权或任何第三方知识产权。您应全额赔偿因在这些资源的使用中对 TI 及其代表造成的任何索赔、损害、成本、损失和债务，TI 对此概不负责。

TI 提供的产品受 TI 的销售条款 (<https://www.ti.com.cn/zh-cn/legal/termsofsale.html>) 或 [ti.com.cn](https://www.ti.com.cn) 上其他适用条款/TI 产品随附的其他适用条款的约束。TI 提供这些资源并不会扩展或以其他方式更改 TI 针对 TI 产品发布的适用的担保或担保免责声明。

邮寄地址：上海市浦东新区世纪大道 1568 号中建大厦 32 楼，邮政编码：200122

Copyright © 2021 德州仪器半导体技术（上海）有限公司